



# OTP Group Sofia World Championships Cadets 2025 Individuals

## Bulgaria, Sofia, 27-30 Aug 2025

**-50 kg**  
Cadets (29)

**POOL A**

	SAHRAOUI Ala Eddine	ALG
	MELO Arthur	BRA
	BOLKVAZDZE Saba	GEO
	ALMALKI Mohammed Waleed M	KSA
	MARKOVIC Petar	SRB
	ALSHAMMARI Abdulwahab	KUW
	ROTASNIUC Artiom	MDA

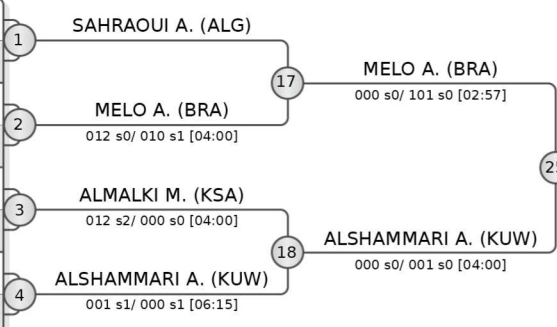

**POOL B**

	SZABO Milan	HUN
	SHODMANOV Mukhammadkodir	UZB
	MAKHATADZE Gabrieli	CAN
	BERDIBEKOV Marselbek	KGZ
	MARTINOV Tsvetelin	BUL
	KHALILLI Rza	AZE
	CHIARRONI CUTILLAS Alejandro	ESP
	ALTANTSAG Bum-Erdene	MGL

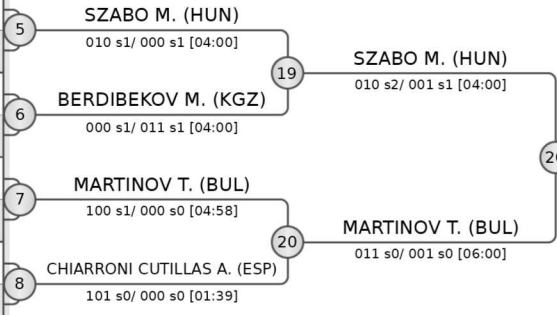

**POOL C**

	CUQ Axel	FRA
	GOULAS Dimitrios	GRE
	SULTANOV Khushnud	UZB
	CRUZ Gabriel	BRA
	CHONG Iek Ian	MAC
	KITAGAWA Julius	GER
	MOR BARAK Omer	ISR

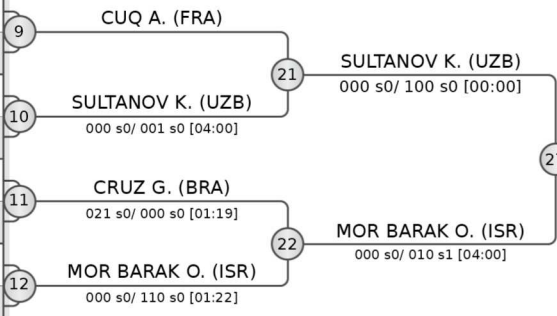

**POOL D**

	GULIYEV Anar	AZE
	DAVTYAN Narek	ARM
	KWADIBANA Dikgang	BOT
	MYSSA Arman	KAZ
	CHIEN Shih-Yun	TPE
	DANAIOV Nikolay	BUL
	ABDELMALAK Samuel	USA

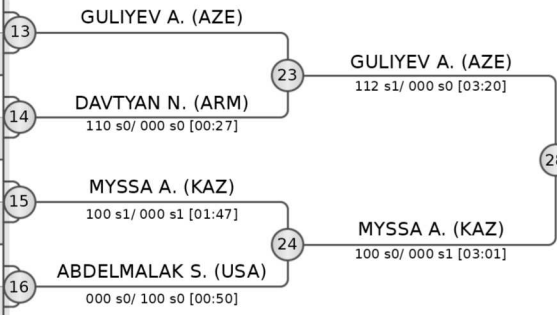

**REPECHAGE**



1.	SULTANOV Khushnud	UZB
2.	MELO Arthur	BRA
3.	MYSSA Arman	KAZ
4.	GULIYEV Anar	AZE
5.	SZABO Milan	HUN
6.	MARTINOV Tsvetelin	BUL
7.	ALSHAMMARI Abdulwahab	KUW
8.	MOR BARAK Omer	ISR





# OTP Group Sofia World Championships Cadets 2025 Individuals

Bulgaria, Sofia, 27-30 Aug 2025

**-55 kg**  
Cadets (37)

**POOL A**

ALIZADA Rasul	AZE	1	ALIZADA R. (AZE)	33	BADAMDORJ B. (MGL)	000 s1/ 001 s1 [04:00]
BADAMDORJ Badar-Uugan	MGL	2	BADAMDORJ B. (MGL)	33	BADAMDORJ B. (MGL)	000 s1/ 001 s1 [04:00]
JAKUBAUSKAS Adris	LTU	3	JAKUBAUSKAS A. (LTU)	34	JAKUBAUSKAS A. (LTU)	001 s0/ 000 s1 [04:00]
FOSER Nik	LIE	4	HOVHANNISYAN V. (ARM)	34	JAKUBAUSKAS A. (LTU)	001 s1/ 000 s1 [04:17]
HOVHANNISYAN Vahe	ARM	4	HOVHANNISYAN V. (ARM)	34	JAKUBAUSKAS A. (LTU)	001 s1/ 000 s1 [04:17]
YELEMES Arsen	KAZ	5	YELEMES A. (KAZ)	35	BURKHONOV K. (UZB)	000 s0/ 010 s0 [04:00]
BURKHONOV Khushnadbek	UZB	6	BURKHONOV K. (UZB)	35	BURKHONOV K. (UZB)	000 s0/ 010 s0 [04:00]
DODERO Andre	BRA	7	TOPTYGIN I. (IJF)	36	TOPTYGIN I. (IJF)	000 s0/ 011 s0 [04:00]
TOPTYGIN Iliia	IJF	7	TOPTYGIN I. (IJF)	36	TOPTYGIN I. (IJF)	000 s0/ 011 s0 [04:00]
NIKOLAKOPOULOS Antonios	GRE	8	NIKOLAKOPOULOS A. (GRE)	36	TOPTYGIN I. (IJF)	011 s0/ 000 s1 [04:00]

**POOL B**

CHIANG Tsan-An	TPE	9	CHIANG T. (TPE)	37	CHIANG T. (TPE)	101 s0/ 000 s0 [02:35]
ELDAN Michael	ISR	10	ELDAN M. (ISR)	37	CHIANG T. (TPE)	101 s0/ 000 s0 [02:35]
ALRAMZI Ali	KUW	11	ALRAMZI A. (KUW)	38	GALENKOV I. (BUL)	000 s1/ 110 s0 [01:18]
GALENKOV Ivo	BUL	12	GALENKOV I. (BUL)	38	GALENKOV I. (BUL)	000 s1/ 110 s0 [01:18]
TERAN Sebastian	USA	13	TERAN S. (USA)	39	BAMAHOFOUZ E. (KSA)	000 s0/ 100 s0 [02:33]
BAMAHOFOUZ Eyad	KSA	14	BAMAHOFOUZ E. (KSA)	39	BAMAHOFOUZ E. (KSA)	000 s0/ 100 s0 [02:33]
GHIDONI Thomas	ITA	15	SORICI A. (ROU)	40	SORICI A. (ROU)	000 s0/ 001 s0 [04:00]
SORICI Alin Marian	ROU	15	SORICI A. (ROU)	40	SORICI A. (ROU)	000 s0/ 001 s0 [04:00]
CARP Maxim	MDA	16	CARP M. (MDA)	40	SORICI A. (ROU)	010 s1/ 000 s2 [07:13]

**POOL C**

GUALANDI Matteo	ITA	17	GUALANDI M. (ITA)	41	GUALANDI M. (ITA)	100 s0/ 000 s0 [01:55]
MAVRIDIS Leonidas	GRE	18	MAVRIDIS L. (GRE)	41	GUALANDI M. (ITA)	100 s0/ 000 s0 [01:55]
UYAR Celil	NED	19	UYAR C. (NED)	42	UYAR C. (NED)	002 s0/ 000 s0 [04:00]
ZVORC Jona	CRO	19	ZVORC J. (CRO)	42	UYAR C. (NED)	002 s0/ 000 s0 [04:00]
HRISTOV Emo	BUL	20	HRISTOV E. (BUL)	42	UYAR C. (NED)	100 s2/ 000 s3 [10:08]
TOPTYGIN Aleksei	IJF	21	TOPTYGIN A. (IJF)	43	TOPTYGIN A. (IJF)	010 s2/ 000 s1 [08:25]
GULUA Aleks	GEO	22	GULUA A. (GEO)	43	TOPTYGIN A. (IJF)	010 s2/ 000 s1 [08:25]
TURARBEB Nurlyzhan	KAZ	23	TURARBEB N. (KAZ)	44	NAHAPETYAN S. (ARM)	000 s1/ 001 s0 [04:19]
NAHAPETYAN Shavarsh	ARM	24	NAHAPETYAN S. (ARM)	44	NAHAPETYAN S. (ARM)	000 s1/ 001 s0 [04:19]

**POOL D**

LUCAS Titouan	FRA	25	LUCAS T. (FRA)	45	LUCAS T. (FRA)	100 s0/ 000 s0 [00:46]
ASIRI Mohammed	KSA	26	ASIRI M. (KSA)	45	LUCAS T. (FRA)	100 s0/ 000 s0 [00:46]
DUBROVSKY Tom	ISR	27	DUBROVSKY T. (ISR)	46	DUBROVSKY T. (ISR)	011 s1/ 000 s0 [04:00]
BROUILLETTE Xavier	CAN	28	BROUILLETTE X. (CAN)	46	DUBROVSKY T. (ISR)	011 s1/ 000 s0 [04:00]
SILVA Victor Hugo	BRA	29	SILVA V. (BRA)	47	HUSIYEV M. (AZE)	000 s0/ 110 s0 [02:22]
HUSIYEV Mohammadali	AZE	30	HUSIYEV M. (AZE)	47	HUSIYEV M. (AZE)	000 s0/ 110 s0 [02:22]
MAHMADSHARIFOV Haidar	TJK	31	MAHMADSHARIFOV H. (TJK)	48	MAHMADSHARIFOV H. (TJK)	003 s0/ 002 s0 [07:14]
TONG Hou Hei	MAC	31	TONG H. (MAC)	48	MAHMADSHARIFOV H. (TJK)	003 s0/ 002 s0 [07:14]
TUMONBAEV Marsel	KGZ	32	TUMONBAEV M. (KGZ)	48	MAHMADSHARIFOV H. (TJK)	003 s0/ 002 s0 [07:14]

**REPECHAGE**

JAKUBAUSKAS A. (LTU)	61	JAKUBAUSKAS A. (LTU)	65	JAKUBAUSKAS A. (LTU)	011 s1/ 000 s0 [04:00]
SORICI A. (ROU)	61	JAKUBAUSKAS A. (LTU)	65	JAKUBAUSKAS A. (LTU)	011 s1/ 000 s0 [04:00]
TOPTYGIN A. (IJF)	62	TOPTYGIN A. (IJF)	66	TOPTYGIN A. (IJF)	100 s0/ 000 s0 [02:17]
DUBROVSKY T. (ISR)	62	TOPTYGIN A. (IJF)	66	TOPTYGIN A. (IJF)	100 s0/ 000 s0 [02:17]
		GALENKOV I. (BUL)	66	TOPTYGIN A. (IJF)	100 s0/ 000 s0 [02:17]

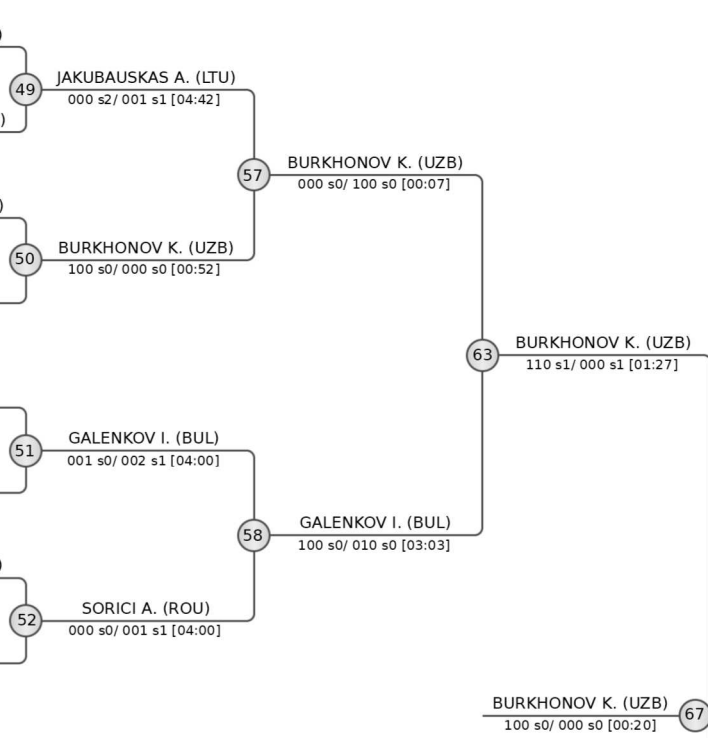

FINAL RESULTS	
1. BURKHONOV Khushnadbek	UZB
2. GUALANDI Matteo	ITA
3. JAKUBAUSKAS Adris	LTU
3. TOPTYGIN Aleksei	IJF
5. HUSIYEV Mohammadali	AZE
5. GALENKOV Ivo	BUL
7. SORICI Alin Marian	ROU
7. DUBROVSKY Tom	ISR







# OTP Group Sofia World Championships Cadets 2025 Individuals

Bulgaria, Sofia, 27-30 Aug 2025

## -60 kg

Cadets (51)

POOL A

ALASGAROV Zeyd AZE	1	ALASGAROV Z. (AZE)	33	ALASGAROV Z. (AZE)
POLYCHRONIDIS Alexandros GRE	2	POLYCHRONIDIS A. (GRE)	010 s2/000 s0 [04:00]	100 s0/000 s0 [01:16]
BUTUCI Kristian CRO	3	GESUELE G. (ITA)	000 s0/100 s0 [00:45]	000 s0/011 s0 [04:00]
SIMON Tege ROU	4	YAMAMOTO L. (BRA)	000 s0/011 s0 [04:00]	
GESUELE Giuseppe ITA	5	MUNIZ ACOSTA J. (POL)		
YAMAMOTO Lucas BRA	6	BATYRGALI Y. (KAZ)	010 s1/020 s0 [05:28]	000 s2/001 s2 [08:59]
MUNIZ ACOSTA Jakub POL	7	TODOROV V. (BUL)	000 s1/010 s0 [07:18]	100 s0/000 s2 [04:00]
GINCESCU Ovidiu MDA	8	TASHTANBEKOV U. (KGZ)		
BATYRGALI Yernur KAZ				
MAKULAVICIUS Rokas LTU				
TODOROV Vladimir BUL				
TASHTANBEKOV Umar KGZ				

POOL B

GARCIA RAMIREZ Diego DOM	9	GARCIA RAMIREZ D. (DOM)	37	GARCIA RAMIREZ D. (DOM)
MAGURA Danilo SRB	10	MAGURA D. (SRB)	101 s0/000 s0 [01:25]	001 s2/000 s1 [04:00]
JANGIRYAN Khachatur ARM	11	KUNYIK B. (HUN)	000 s0/101 s0 [03:02]	110 s0/000 s0 [01:41]
KUNYIK Botond HUN	12	ALMEHMADI A. (KSA)	000 s0/022 s0 [03:21]	
COHEN Adrian USA	13	NARMANDAKH T. (MGL)	011 s2/000 s1 [04:00]	011 s2/000 s1 [04:00]
ALMEHMADI Ahmed KSA	14	SNIR Y. (ISR)	000 s0/020 s0 [01:49]	000 s2/001 s2 [09:53]
NARMANDAKH Tegsh-Ochir MGL	15	KARIMOV D. (UZB)	000 s0/010 s1 [04:00]	001 s1/000 s2 [04:00]
TCHIBERASHVILI Vakhtangi GEO	16	AFXENTIOU A. (CYP)	000 s0/022 s0 [03:21]	
SNIR Yoav David ISR				
GLASER Julius GER				
KARIMOV Dilshod UZB				
POGREB Max AUS				
AFXENTIOU Afxentis CYP				

POOL C

DEGOUAH Mohamed Amine ALG	17	DEGOUAH M. (ALG)	41	KUDBUDINOV L. (TJK)
KUDBUDINOV Loiq TJK	18	KUDBUDINOV L. (TJK)	020 s1/000 s1 [02:38]	000 s3/100 s0 [03:17]
HADJIYANNIS Nestoras CYP	19	ALEKSEJUNAS N. (LTU)	000 s1/100 s0 [01:23]	000 s0/110 s1 [03:04]
PEAKE Crosby AUS	20	KESLER L. (USA)	000 s0/110 s1 [03:04]	
ALEKSEJUNAS Natas LTU	21	FEDORA F. (HUN)		
KESLER Liam USA	22	AZARUMYAN A. (EST)	000 s0/001 s2 [04:02]	000 s2/100 s1 [05:18]
FEDORA Ferenc HUN	23	BALJINNYAM Tsolmon-Od MGL	000 s0/100 s0 [00:46]	000 s2/001 s2 [09:53]
ZWIERS Morris NED	24	KO P. (TPE)	000 s0/100 s0 [00:46]	110 s0/000 s0 [02:29]
AZARUMYAN Artak EST		REIS A. (POR)	010 s0/001 s1 [04:00]	101 s0/000 s0 [01:24]
BALJINNYAM Tsolmon-Od MGL		HAROUN Almashni JOR		
KO Po-Erh TPE				
REIS Afonso POR				
HAROUN Almashni JOR				

POOL D

ICHKITIDZE Tsotne GEO	25	ICHKITIDZE T. (GEO)	45	ICHKITIDZE T. (GEO)
MAYORGA Jorge GUA	26	MAYORGA J. (GUA)	100 s1/000 s0 [01:35]	000 s2/001 s2 [08:40]
RADANOV Nikola SRB	27	ROTSOS P. (GRE)	020 s0/000 s1 [02:03]	000 s0/101 s0 [00:44]
ROTSOS Petros GRE	28	HASHIMA T. (JPN)	000 s0/101 s0 [00:44]	
ALFAJARE Jacob PLE	29	KABDESHOV B. (KAZ)		
HASHIMA Toai JPN	30	SODANO R. (ITA)	000 s1/001 s1 [05:47]	000 s1/001 s1 [05:47]
KABDESHOV Bakdaulet KAZ	31	NOSIROV M. (UZB)	000 s1/012 s1 [04:00]	000 s0/002 s1 [04:00]
GAYIBOV Royal AZE	32	TEMIRBAEV A. (CAN)	000 s0/001 s1 [07:50]	001 s1/000 s2 [04:00]
SODANO Raffaele ITA				
DIMITROV Samuil BUL				
NOSIROV Mukhammadkarim UZB				
KUZNETSOV Roman BLR				
TEMIRBAEV Amir CAN				

REPECHAGE

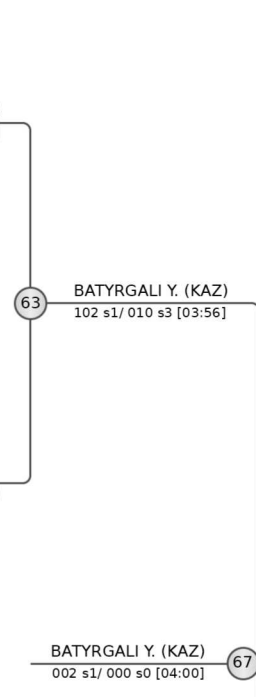
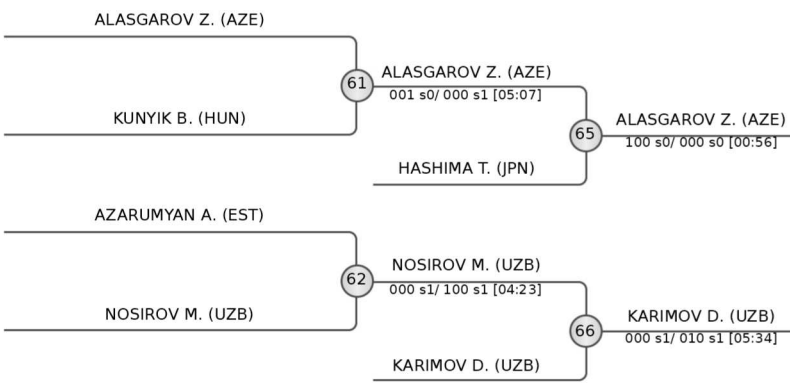

FINAL RESULTS	
1. BATYRGALI Yernur	KAZ
2. KUDBUDINOV Loiq	TJK
3. ALASGAROV Zeyd	AZE
4. KARIMOV Dilshod	UZB
5. HASHIMA Toai	JPN
6. NOSIROV Mukhammadkarim	UZB
7. KUNYIK Botond	HUN
8. AZARUMYAN Artak	EST





# OTP Group Sofia World Championships Cadets 2025 Individuals

Bulgaria, Sofia, 27-30 Aug 2025

## -66 kg

Cadets (39)

POOL A

	JANKOVIC Boris	SRB	1
	KOTIEV Muslim	IJF	2
	PAZ Emiliano	BOL	3
	BABRAVICIUS Vincentas	LTU	3
	GAL Kristof	HUN	4
	CORMACK Angus	AUS	5
	ABDRAIMOV Narmatbek	KGZ	6
	BOURNIGAL OLIVERO Ernesto	DOM	7
	ONAY Numan	TUR	7
	REYES Anthony	USA	8

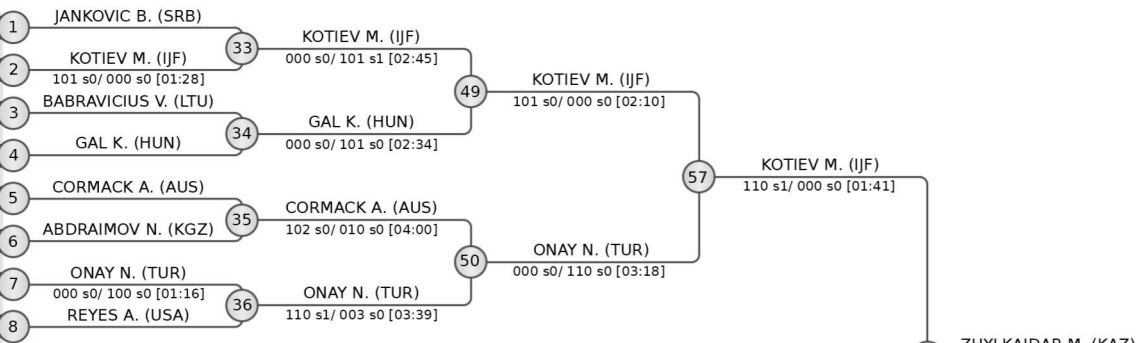

POOL B

	LEDESMA Agustin	PAR	9
	SULAIMONOV Muhamadyosin	TJK	10
	ROZGA Roko	CRO	11
	MATI Anes	CAN	11
	AL-SAADY Saleh	QAT	12
	ELSAYED Youssef	EGY	13
	MARZOUQ Meshari	KUW	14
	NIKOLCHEV Ivan	BUL	14
	MITSUDA Fernando	BRA	15
	ZHYLKAIIDAR Mukhammedali	KAZ	16

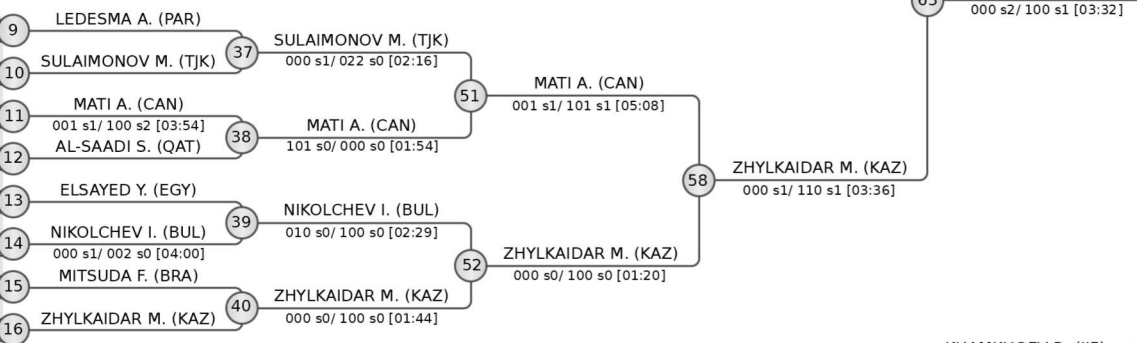

POOL C

	KHAMKHOEV Rakhim	IJF	17
	HADZI-VELJKOVIC Nikola	CRO	18
	KULDOSHBOEV Sultonbek	UZB	18
	CHINTOGTOKH Temuulen	MGL	19
	AZDANIN Ashraf	JOR	20
	NOGES Georg	EST	21
	FRIEDRICH Noam	ISR	22
	BOLOTBEKOV Arsen	KGZ	22
	LAPAIX RAMIREZ Adrian	DOM	23
	KARALEVICIUS Zygimantas	LTU	24

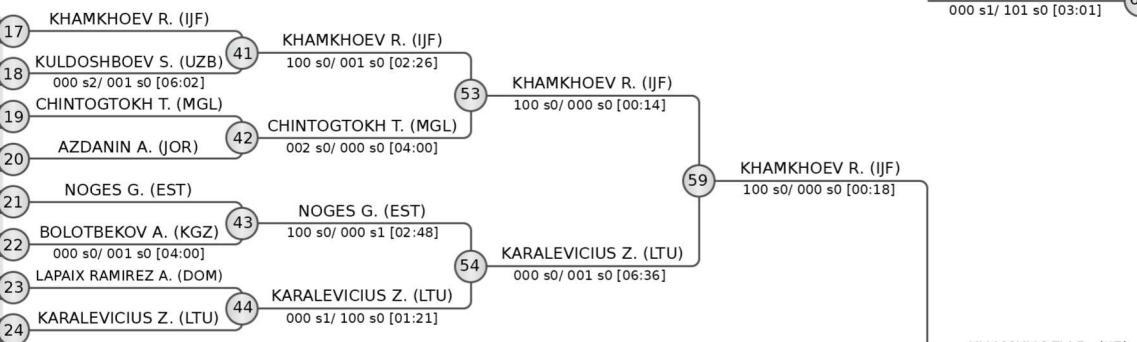

POOL D

	GALLANT Connor	CAN	25
	NIKOLOV Preslav	BUL	26
	RIOS Dan	VEN	27
	ALKANDARI Khaled	KUW	28
	OTEVREL Tomas	CZE	29
	ZWIERS Tyn	NED	30
	ROTASNIUC Ivan	MDA	31
	TABET Ishak	FRA	31
	KAIRGALI Rolan	KAZ	32

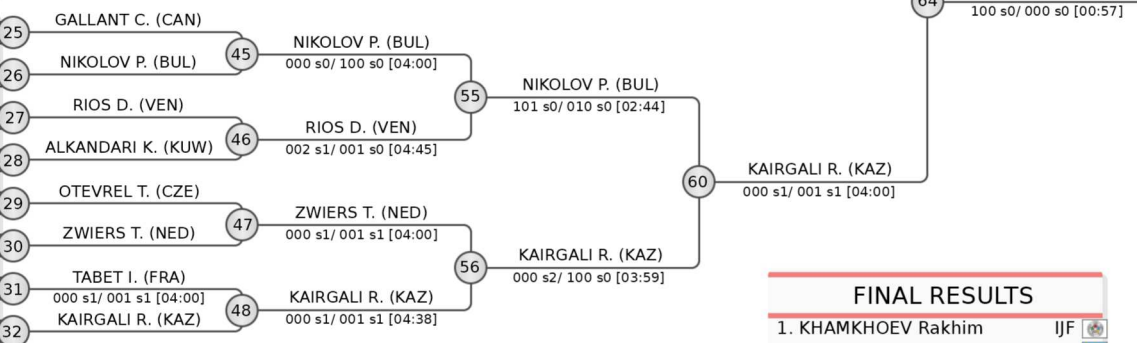

REPECHAGE

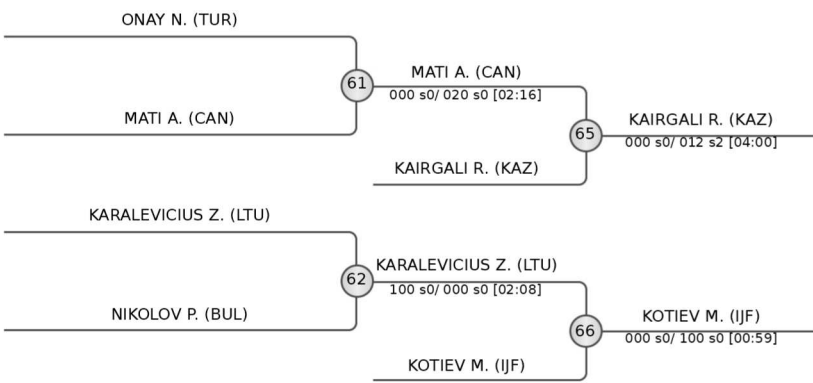

### FINAL RESULTS

1. KHAMKHOEV Rakhim IJF
2. ZHYLKAIIDAR Mukhammedali KAZ
3. KAIRGALI Rolan KAZ
3. KOTIEV Muslim IJF
5. MATI Anes CAN
5. KARALEVICIUS Zygimantas LTU
7. ONAY Numan TUR
7. NIKOLOV Preslav BUL







# OTP Group Sofia World Championships Cadets 2025 Individuals

Bulgaria, Sofia, 27-30 Aug 2025

## -73 kg

Cadets (42)

### POOL A

1	VARNICIC Veljko (SRB)	SRB	1	VARNICIC V. (SRB)
2	BRUZHANITSKY Tal (ISR)	ISR	2	BRUZHANITSKY T. (ISR)
3	SAMSIANI Ieso (GEO)	GEO	3	BICHOEV A. (IJF)
4	BICHOEV Atkhan (IJF)	IJF	4	AGHAKISHIYEV M. (AZE)
5	AGHAKISHIYEV Mahammad (AZE)	AZE	5	AGHAKISHIYEV M. (AZE)
6	RUSNAK Adam (CZE)	CZE	6	RUSNAK A. (CZE)
7	STANKEVICIUS Ignas (LTU)	LTU	7	DANISCA V. (MDA)
8	DANISCA Vladimir (MD)	MD	8	SHAROPOV B. (TJK)
9	BARANAU Ivan (USA)	USA	9	SHAROPOV B. (TJK)
10	SHAROPOV Bobodzhon (TJK)	TJK	10	KODRIC L. (SLO)
11	KODRIC Luka (SLO)	SLO	11	

### POOL B

9	BATBUYAN Dalaitseren (MGL)	MGL	9	BATBUYAN D. (MGL)
10	LE BRIS Lowan (CAN)	CAN	10	LE BRIS L. (CAN)
11	BABACHEV Stiliyan (BUL)	BUL	11	BABACHEV S. (BUL)
12	MOURA Joao Gabriel (BRA)	BRA	12	MEIER G. (LIE)
13	MEIER Gabriel (LIE)	LIE	13	RAVSHANOV S. (UZB)
14	RAVSHANOV Sadulla (UZB)	UZB	14	ALJADI A. (KUW)
15	ALJADI Ali (KUW)	KUW	15	LAZARIDES S. (CYP)
16	LAZARIDES Stefanos (CYP)	CYP	16	JAMAK A. (BIH)
17	GALSTYAN Gor (ARM)	ARM	17	
18	JAMAK Ahmed (BIH)	BIH	18	

### POOL C

17	GAMEZARDASHVILI Vasil (GEO)	GEO	17	GAMEZARDASHVILI V. (GEO)
18	GKOLIAS Efthymios (GRE)	GRE	18	KLIMSA J. (CZE)
19	KLIMSA Jan (CZE)	CZE	19	SARUKHANYAN T. (ARM)
20	SARUKHANYAN Tigran (ARM)	ARM	20	BAYARJAVKHLAN T. (MGL)
21	BAYARJAVKHLAN Temuulen (MGL)	MGL	21	LEVIN S. (ISR)
22	LEVIN Shahaf (ISR)	ISR	22	MIKONIS Dangiras (LTU)
23	MIKONIS Dangiras (LTU)	LTU	23	MITSUISHI Keisho (JPN)
24	MITSUISHI Keisho (JPN)	JPN	24	HAVRANEK J. (CRO)
25	HAVRANEK Josip (CRO)	CRO	25	RAMIREZ Rafael (MEX)
26	RAMIREZ Rafael (MEX)	MEX	26	PERALTA Enzo (PAR)
27	PERALTA Enzo (PAR)	PAR	27	

### POOL D

25	KYDYRBAY Myrzatay (KAZ)	KAZ	25	KYDYRBAY M. (KAZ)
26	MIHALEV Nikolaz (BUL)	BUL	26	MIHALEV N. (BUL)
27	HAMDAOUI Ahmed-Adam (FRA)	FRA	27	HAMDAOUI A. (FRA)
28	ALEINIKOV Alexandr (BLR)	BLR	28	KRIVOLAPOV E. (KGZ)
29	KRIVOLAPOV Egor (KGZ)	KGZ	29	MILJIC S. (SRB)
30	MILJIC Sinisa (SRB)	SRB	30	KEASBERRY R. (NED)
31	LEAH Maxim (MDA)	MDA	31	KEASBERRY R. (NED)
32	KEASBERRY Rover (NED)	NED	32	ALKHALAF Abdulmajeed Sakhr M (KSA)
33	ALKHALAF Abdulmajeed Sakhr M (KSA)	KSA	33	CHARALAMPOUS V. (CYP)
34	CHARALAMPOUS Vladimirov (CYP)	CYP	34	

### REPECHAGE

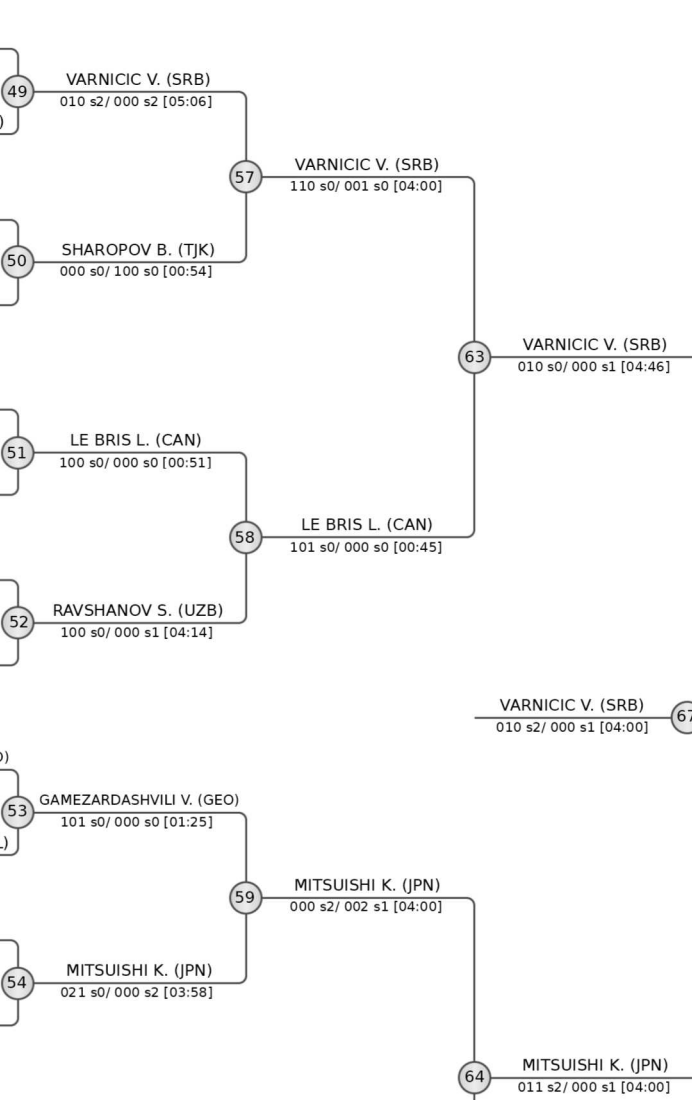
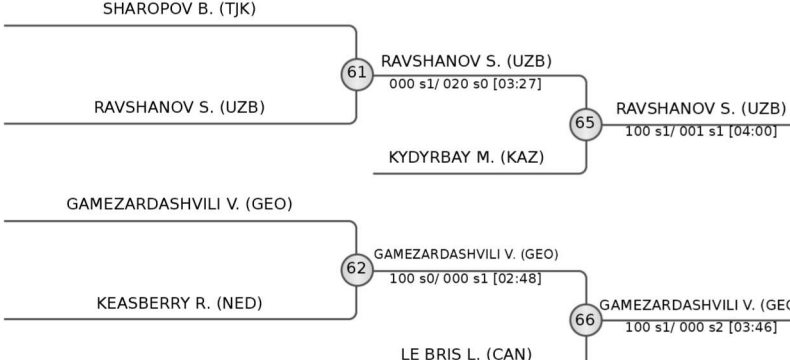

### FINAL RESULTS

1.	VARNICIC Veljko	SRB
2.	MITSUISHI Keisho	JPN
3.	RAVSHANOV Sadulla	UZB
4.	GAMEZARDASHVILI Vasil	GEO
5.	KYDYRBAY Myrzatay	KAZ
5.	LE BRIS Lowan	CAN
7.	SHAROPOV Bobodzhon	TJK
7.	KEASBERRY Rover	NED





# OTP Group Sofia World Championships Cadets 2025 Individuals

## Bulgaria, Sofia, 27-30 Aug 2025

**-81 kg**  
Cadets (33)

**POOL A**

BABAICENKO Tajus	LTU	1	BABAICENKO T. (LTU)
NAPSO Aslan	ISR	2	NAPSO A. (ISR)
DIMITROV Hristo	BUL	3	IMANALYEV N. (KGZ)
IMANALYEV Nuradil	KGZ	3	000 s1/001 s1 [04:00]
GEVORGYAN Zhora	ARM	4	GEVORGYAN Z. (ARM)
BAKHODIROV Inomjon	UZB	5	BAKHODIROV I. (UZB)
THOMAS III Derick	USA	6	THOMAS III D. (USA)
SARGHEOLIU Alexandru	MDA	7	SARGHEOLIU A. (MDA)
COPRA Ahmed	BIH	8	COPRA A. (BIH)

**POOL B**

DISTEL Konstantin	GER	9	DISTEL K. (GER)
ABDUJALILZODA Abubakr	TJK	10	ABDUJALILZODA A. (TJK)
BOUNTANIOTIS Georgios	GRE	11	BOUNTANIOTIS G. (GRE)
SEMANJAKU Erik	ITA	12	SEMANJAKU E. (ITA)
ALIEV Timur	IJF	13	ALIEV T. (IJF)
HSIEH Yun-Chi	TPE	14	HSIEH Y. (TPE)
IAKOVOU Michalis	CYP	15	IAKOVOU M. (CYP)
VASCONCELOS Ruan	BRA	16	VASCONCELOS R. (BRA)

**POOL C**

KELLY Akos	AUS	17	KELLY A. (AUS)
KATSARSKI Teodor	BUL	18	KATSARSKI T. (BUL)
BATJARGAL Mungundul	MGL	19	BATJARGAL M. (MGL)
RUSSO Edoardo Michele	ITA	20	RUSSO E. (ITA)
SIMONOV Aleksandr	KGZ	21	SIMONOV A. (KGZ)
KRIVEC Aleks	SLO	22	KRIVEC A. (SLO)
SAIKALY Diego	LBN	23	SAIKALY D. (LBN)
SARBOCH Adam	CZE	24	SARBOCH A. (CZE)

**POOL D**

MUMLADZE Giorgi	GEO	25	MUMLADZE G. (GEO)
CHARALAMPOUS Miltiadis	CYP	26	CHARALAMPOUS M. (CYP)
GONZALEZ ORTEGA Ivan Gregorio	MEX	27	GONZALEZ ORTEGA I. (MEX)
TCHENDJE KENMEUE Arthur	FRA	28	TCHENDJE KENMEUE A. (FRA)
BOURQUE Tristan	CAN	29	BOURQUE T. (CAN)
BOUQAMMAZ Anas	KUW	30	BOUQAMMAZ A. (KUW)
GUSIC Sulejman	BIH	31	GUSIC S. (BIH)
KHIDIROV Ramazan	IJF	32	KHIDIROV R. (IJF)

**REPECHAGE**

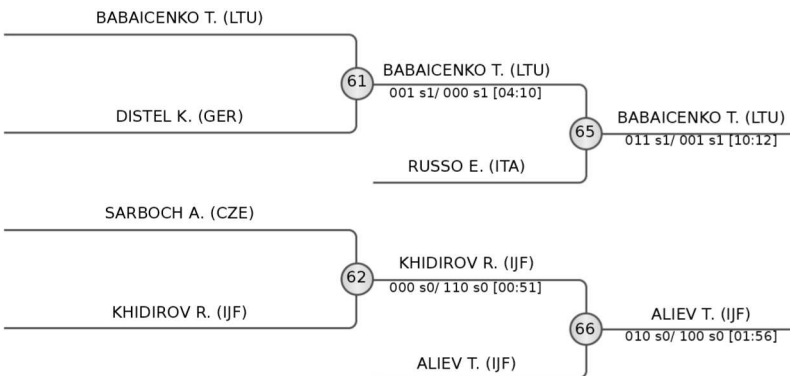

FINAL RESULTS	
1.	BAKHODIROV Inomjon UZB
2.	MUMLADZE Giorgi GEO
3.	BABAICENKO Tajus LTU
3.	ALIEV Timur IJF
5.	KHIDIROV Ramazan IJF
7.	DISTEL Konstantin GER
7.	SARBOCH Adam CZE







# OTP Group Sofia World Championships Cadets 2025 Individuals

Bulgaria, Sofia, 27-30 Aug 2025

## -90 kg

Cadets (33)

POOL A

GENYS Majus	LTU	1
GRIEDE Sieb	NED	2
STROKUN Maksim	BLR	3
GIANNAKOS Dimitrios	GRE	4
SIMIC Nemanja	SRB	5
SUNDBY Marius	NOR	6
CAPEZZUTO Antonio	ITA	7
SALIEV Alikhan	KGZ	8

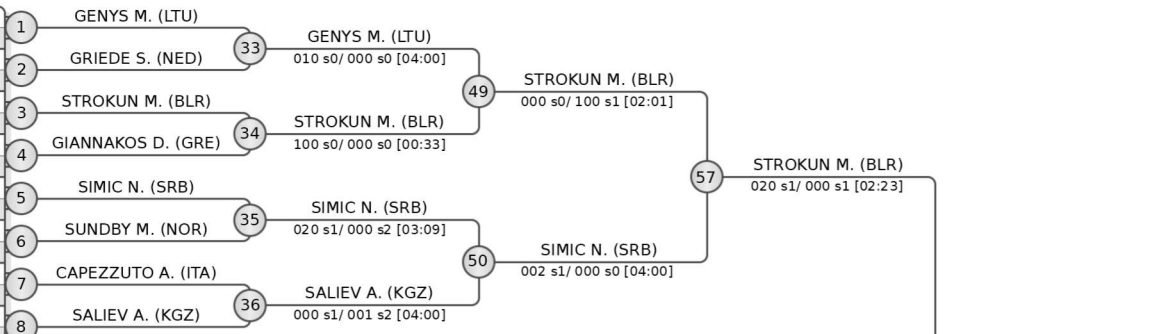

POOL B

TOKTAR Batyrzhan	KAZ	9
UTSIEV Apti	IJF	10
SHAIKH MUBARK Mohammed	KSA	11
ALDAIHANI Abdullah	KUW	12
DE GODOY TRISTANTE Cesar	BRA	13
VUJICA Marko	CRO	14
NAMSRAIJAV Amartuvshin	MGL	15
STANEV Zdravko	BUL	16

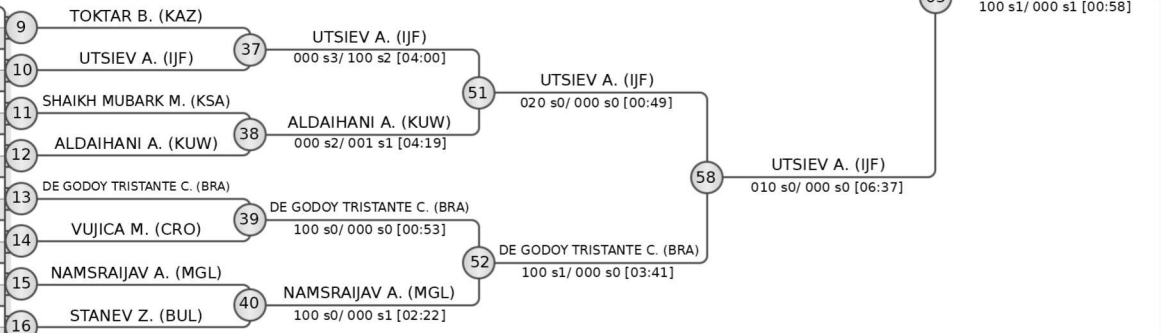

POOL C

SULEIMANOV Abdula	IJF	17
IOANNOU Markelos	CYP	18
VALKOV Tsvetomir	BUL	19
NEACSU Rares	ROU	20
MAZZON Francesco	ITA	21
AITMATOV Beksultan	KGZ	22
KIRYLAU Arseni	BLR	23
ZAKARYAN Sergey	ARM	24

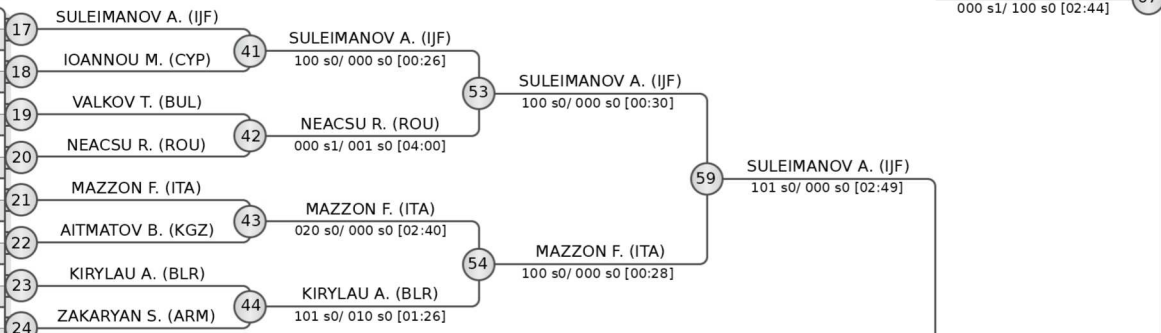

POOL D

ZURABASHVILI Giorgi	GEO	25
ZADVINSKIY Nicholas	USA	26
SVATEK Jozef	SVK	27
MOLCHANOV Matthew	CAN	28
KOSTELIDIS Angelos	GRE	29
AHROROV Musurmonkul	UZB	30
PETRAUSKAS Majus	LTU	31
ALSHATI Mohammed	KUW	32
FRANCA Aljaz	SLO	32

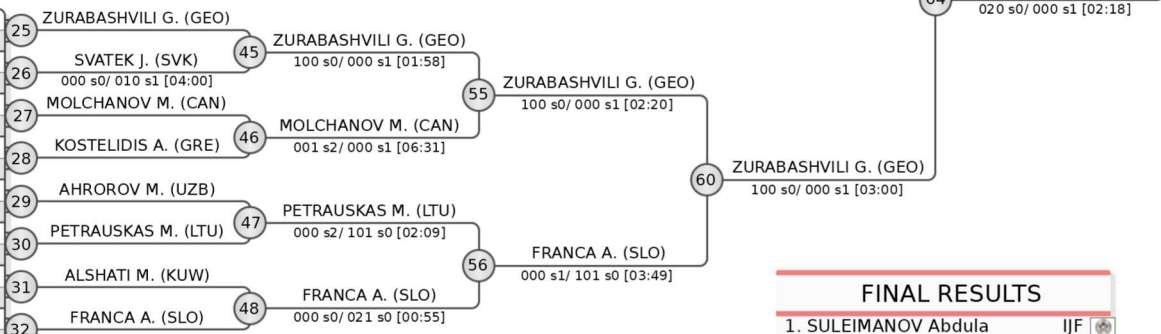

REPECHAGE

SIMIC N. (SRB)	61
DE GODOY TRISTANTE C. (BRA)	62
MAZZON F. (ITA)	63
FRANCA A. (SLO)	64

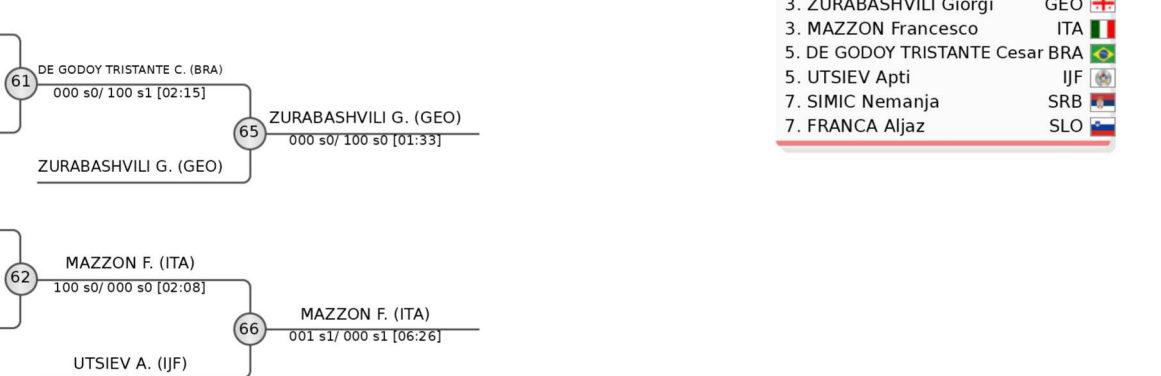

### FINAL RESULTS

1. SULEIMANOV Abdula	IJF
2. STROKUN Maksim	BLR
3. ZURABASHVILI Giorgi	GEO
3. MAZZON Francesco	ITA
5. DE GODOY TRISTANTE Cesar	BRA
7. UTSIEV Apti	IJF
7. SIMIC Nemanja	SRB
7. FRANCA Aljaz	SLO





# OTP Group Sofia World Championships Cadets 2025 Individuals

Bulgaria, Sofia, 27-30 Aug 2025

**+ 90 kg**  
Cadets (30)

**POOL A**

	UEYAMA Kanta	USA
	STIVENSON Arthur	CAN
	CORSICA Michele	ITA
	BANAEIAN TOLKI Mohammadpouria	IRI
	BISCHOFF Samuel	GER
	SKODA Melichar	CZE
	COSTA Nicolas	BRA

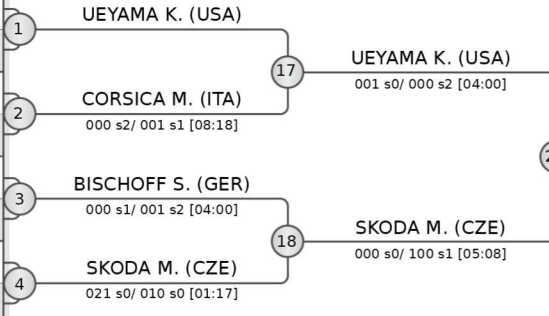

**POOL B**

	LI Yi-An	TPE
	BOISSONNET Hugo	FRA
	SZEKERES Abel	HUN
	DURDIEV Alibek	UZB
	ABALAKI Ioane	GEO
	VAN ADRICHEM Thomas	NED
	GALSANDAMBA Munkhbagana	MGL
	KULIGIN Denis	IJF

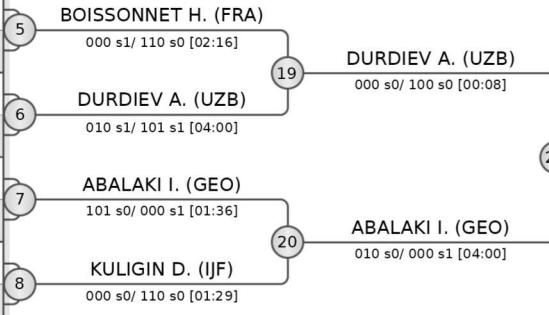

**POOL C**

	AKHUNDOV Subhan	AZE
	TOKITA Kaito	JPN
	ALOB Aidan Ahmad	KUW
	ABDALLA Abdalla	EGY
	NOVAKOVIC Petar	SRB
	ZHAUDINOV Adilzhan	KAZ
	DEKENNE DIFFO Azriel	FRA

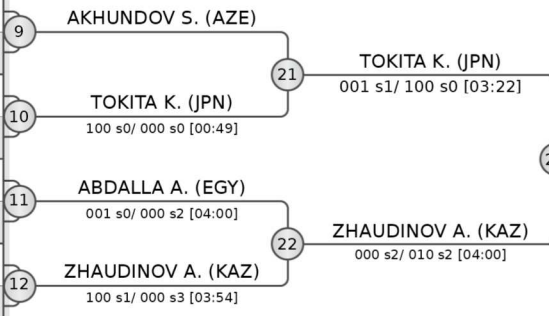

**POOL D**

	CSERMAK Daniel	HUN
	LUBURA Nikola	BIH
	HARRIS Judah	USA
	MARKOV Nikola	BUL
	KARCHAIDZE Giorgi	GEO
	HAYEK Ali	MOZ
	PICCHI Gianluca	ITA
	MOUSSIMA EWANE ELOUTI Franck David	CAN

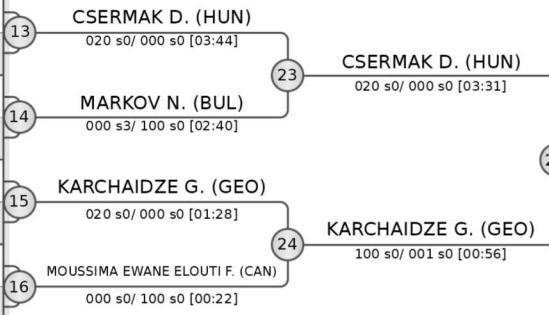

**REPECHAGE**

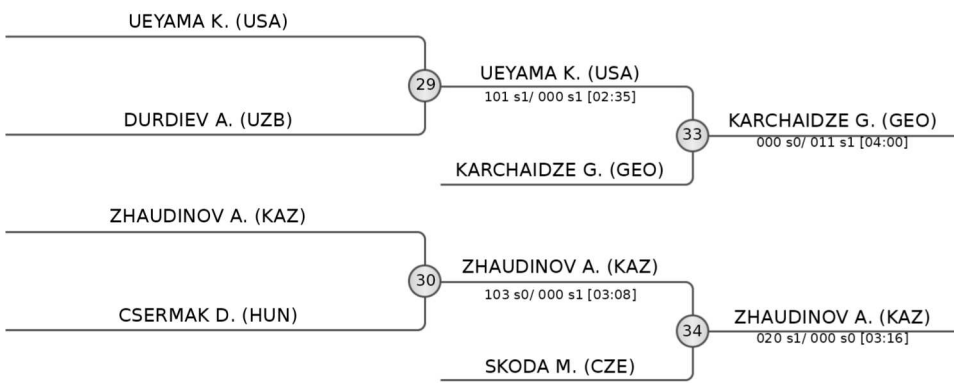

FINAL RESULTS	
1.	ABALAKI Ioane (GEO)
2.	TOKITA Kaito (JPN)
3.	KARCHAIDZE Giorgi (GEO)
3.	ZHAUDINOV Adilzhan (KAZ)
5.	UEYAMA Kanta (USA)
5.	SKODA Melichar (CZE)
7.	DURDIEV Alibek (UZB)
7.	CSERMAK Daniel (HUN)







# OTP Group Sofia World Championships Cadets 2025 Individuals

## Bulgaria, Sofia, 27-30 Aug 2025

**-40 kg**  
Cadets (17)

**POOL A**

	YUKSEL Sema Nur	TUR
	BLASZCZYK Julia	POL
	DAHOUMANE Nadine Chiraz	ALG
	VUKMIROVIC Hana	SRB

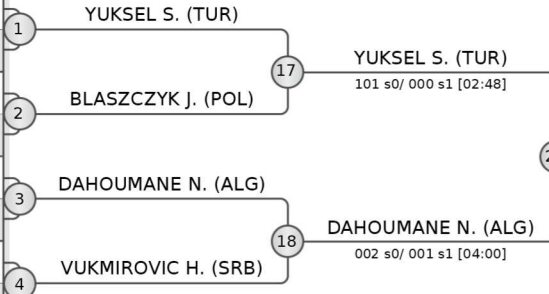

**POOL B**

	YILMAZTURK Yagmur	TUR
	KOLUCHEVA Alina	UZB
	PRYAKHINA Ulyana	KAZ
	BAYARZUL Khulan	MGL

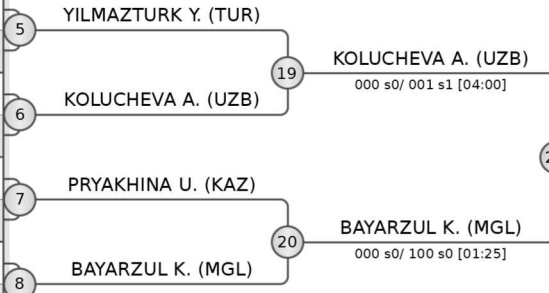

**POOL C**

	PEETERS Fenne	BEL
	ITSKOV Rivka	ISR
	SAIFUTDINOVA Emiliia	IJF
	CIUMAS Bianca	ROU

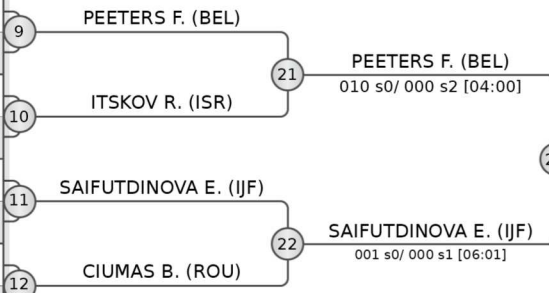

**POOL D**

	RADICS Maja	HUN
	STEPANOVA Anastasiia	KGZ
	SENA Ana Paula	BRA
	TURSI Giada	ITA
	BOLTABOEVA Dilafruz	UZB

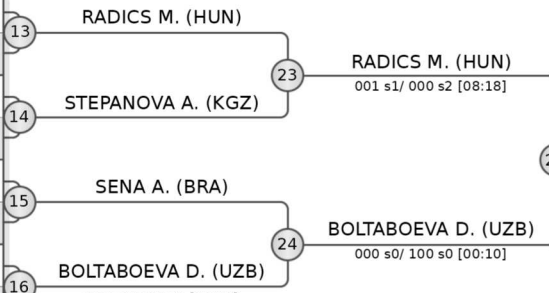

**REPECHAGE**

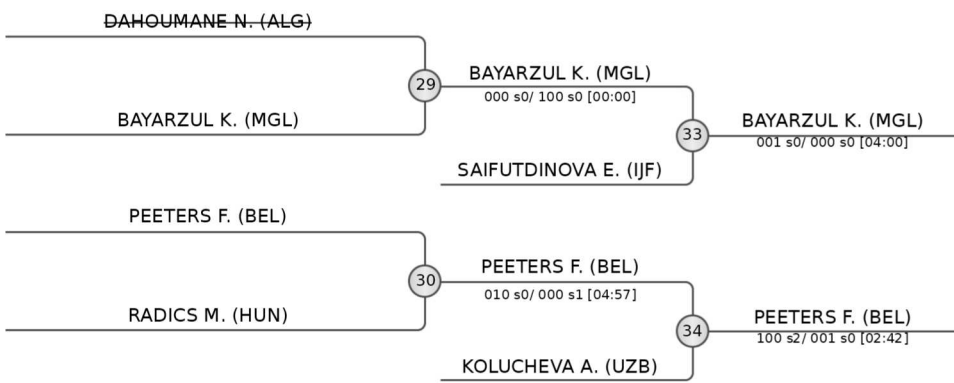

FINAL RESULTS	
1.	BOLTABOEVA Dilafruz UZB
2.	YUKSEL Sema Nur TUR
3.	BAYARZUL Khulan MGL
3.	PEETERS Fenne BEL
5.	SAIFUTDINOVA Emiliia IJF
5.	KOLUCHEVA Alina UZB
7.	DAHOUMANE Nadine Chiraz ALG
7.	RADICS Maja HUN





# OTP Group Sofia World Championships Cadets 2025 Individuals

Bulgaria, Sofia, 27-30 Aug 2025

**-44 kg**  
Cadets (28)

**POOL A**

	MISHENKINA Nadezhda	IJF	1	MISHENKINA N. (IJF)
	GORANOVIC Katarina	SRB	2	GORANOVIC K. (SRB)
	VASILEVA Ema	BUL		011 s0/ 000 s2 [04:00]
	AUREL Mathilde	FRA	3	AUREL M. (FRA)
	AZARUMYAN Anna	EST		110 s0/ 000 s0 [00:46]
	YANG Zi-Yu	TPE	4	YANG Z. (TPE)
	STORIONE Ludovica	ITA		001 s2/ 000 s2 [09:19]

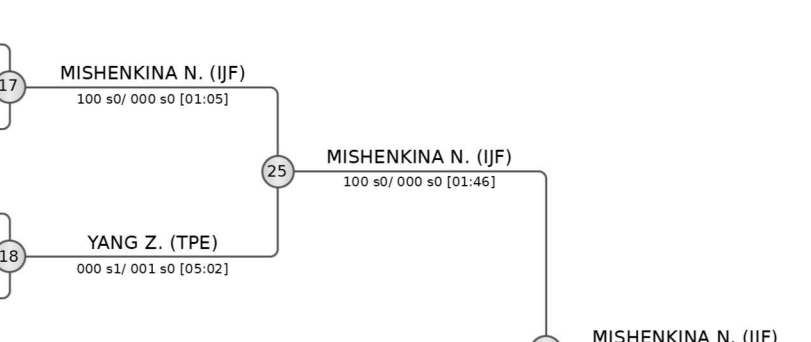

**POOL B**

	BELL Amaris	USA	5	BELL A. (USA)
	ABDULLAYEVA Khadija	AZE	6	ABDULLAYEVA K. (AZE)
	SEITZHANOVA Ainara	KAZ		110 s0/ 000 s0 [02:23]
	MEKI Fatma Zehra	TUR	7	MEKI F. (TUR)
	MARKOU Maria Eleni	GRE		101 s0/ 000 s0 [01:23]
	CUSA Carla	ROU	8	SPONSELEE M. (NED)
	SPONSELEE Mare	NED		002 s0/ 003 s1 [05:34]

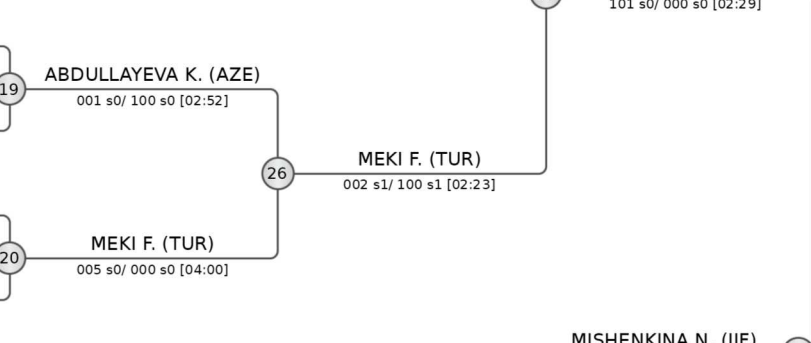

**POOL C**

	WALENDZIK Sandra	POL	9	WALENDZIK S. (POL)
	SERBAN Denisa	ROU	10	SERBAN D. (ROU)
	SAKHABADIN Inzhu	KAZ		001 s1/ 000 s1 [04:00]
	GABAY Yuval	ISR	11	GABAY Y. (ISR)
	TODOROVA Ivon	BUL		100 s1/ 000 s3 [03:58]
	KHASANOVA Dinora	UZB	12	IMHOF G. (BRA)
	IMHOF Giovanna	BRA		000 s0/ 001 s2 [04:00]

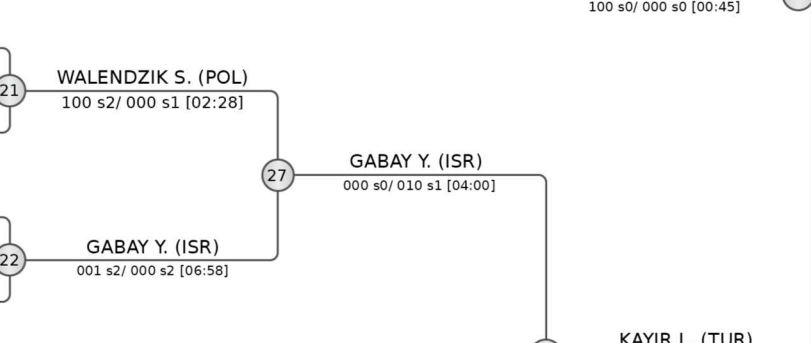

**POOL D**

	KAYIR Livanur	TUR	13	KAYIR L. (TUR)
	GRIGORYAN Viktoria	BEL	14	MANASBEKOVA M. (KGZ)
	MANASBEKOVA Munira	KGZ		002 s3/ 100 s1 [02:51]
	TSOGBADRAKH Amin-Erdene	MGL	15	FERRO A. (ITA)
	FERRO Aurora	ITA		000 s3/ 100 s0 [04:10]
	PRITULEAC Iana	MDA	16	HUSEYNOVA G. (AZE)
	HUSEYNOVA Gulshan	AZE		000 s1/ 111 s0 [02:45]



**REPECHAGE**

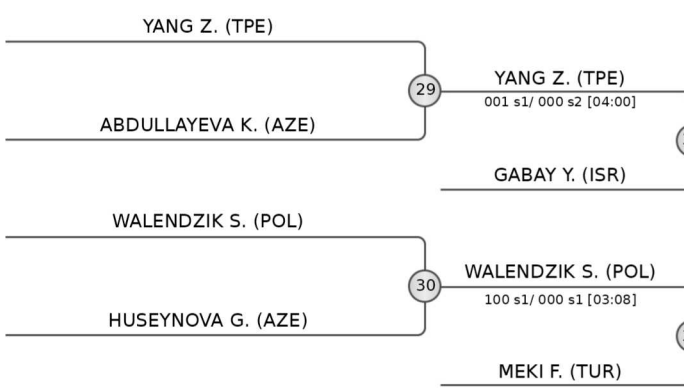

1.	MISHENKINA Nadezhda	IJF
2.	KAYIR Livanur	TUR
3.	YANG Zi-Yu	TPE
3.	WALENDZIK Sandra	POL
5.	GABAY Yuval	ISR
5.	MEKI Fatma Zehra	TUR
7.	ABDULLAYEVA Khadija	AZE
7.	HUSEYNOVA Gulshan	AZE







# OTP Group Sofia World Championships Cadets 2025 Individuals

Bulgaria, Sofia, 27-30 Aug 2025

**-48 kg**  
Cadets (39)

**POOL A**

1	TWAROWSKA Barbara	POL	1	TWAROWSKA B. (POL)
2	MOREOSELE Pine	BOT	2	MOREOSELE P. (BOT)
3	TALGARTBEKOVA Iasemin	KGZ	3	TALGARTBEKOVA I. (KGZ)
4	WSHAH Houda	JOR	4	WSHAH H. (JOR)
5	VAINER Xenia	MDA	5	VAINER X. (MDA)
6	ZAKHAROVA Sofia	IJF	6	ZAKHAROVA S. (IJF)
7	MENDES Sarah	BRA	7	MENDES S. (BRA)
8	ALTANSHAGAI Misheel	MGL	8	ALTANSHAGAI M. (MGL)
9	STOJMILOVSKA Anamarija	MKD	9	STOJMILOVSKA A. (MKD)
10	PANTSKHAVA Nini	GEO	10	PANTSKHAVA N. (GEO)

11	AGHAMIRZAZADE Narmin	AZE	11	AGHAMIRZAZADE N. (AZE)
12	IDDIR Celine	FRA	12	IDDIR C. (FRA)
13	RUSLANOVA Assel	KAZ	13	RUSLANOVA A. (KAZ)
14	GRIGOROVA Kalina	BUL	14	GRIGOROVA K. (BUL)
15	DAPA Maelys	BEL	15	DAPA M. (BEL)
16	PAZ Noelia	BOL	16	PAZ N. (BOL)
17	PLICH Emily Chiara	GER	17	PLICH E. (GER)
18	TUCAJ Martina	CRO	18	TUCAJ M. (CRO)
19	STAVROPOULOU Iliana	GRE	19	STAVROPOULOU I. (GRE)

**POOL C**

20	RIBEIRO Clarice	BRA	20	RIBEIRO C. (BRA)
21	TOMITA Iori	JPN	21	TOMITA I. (JPN)
22	ALAKBAROVA Leyla	AZE	22	ALAKBAROVA L. (AZE)
23	ARIUNZORIG Khongorzul	MGL	23	ARIUNZORIG K. (MGL)
24	CHAIYOU Konstantina	GRE	24	CHAIYOU K. (GRE)
25	HERTA Gabriela	MDA	25	HERTA G. (MDA)
26	TAMURA Addyson	CAN	26	TAMURA A. (CAN)
27	MONTALBANO Aurora	ITA	27	MONTALBANO A. (ITA)
28	NIDAOUI Fatima Ezzahra	MAR	28	NIDAOUI F. (MAR)
29	ZHUKOVICH Nadzeya	BLR	29	ZHUKOVICH N. (BLR)

**POOL D**

30	HIROSE Rika	AUS	30	HIROSE R. (AUS)
31	BAR LEV Ella	ISR	31	BAR LEV E. (ISR)
32	MANIBOG Malia	USA	32	MANIBOG M. (USA)
33	MOUSSATI Nourane	FRA	33	MOUSSATI N. (FRA)
34	MATEJKOVA Teresa	SVK	34	MATEJKOVA T. (SVK)
35	MARTIN CARRICHES Aiora	ESP	35	MARTIN CARRICHES A. (ESP)
36	TOLENTINO Carla	DOM	36	TOLENTINO C. (DOM)
37	KOVACHEVA Preslava	BUL	37	KOVACHEVA P. (BUL)
38	MAZUR Sofia	KGZ	38	MAZUR S. (KGZ)
39	KHOLMURZAEVA Gulmira	UZB	39	KHOLMURZAEVA G. (UZB)

**REPECHAGE**

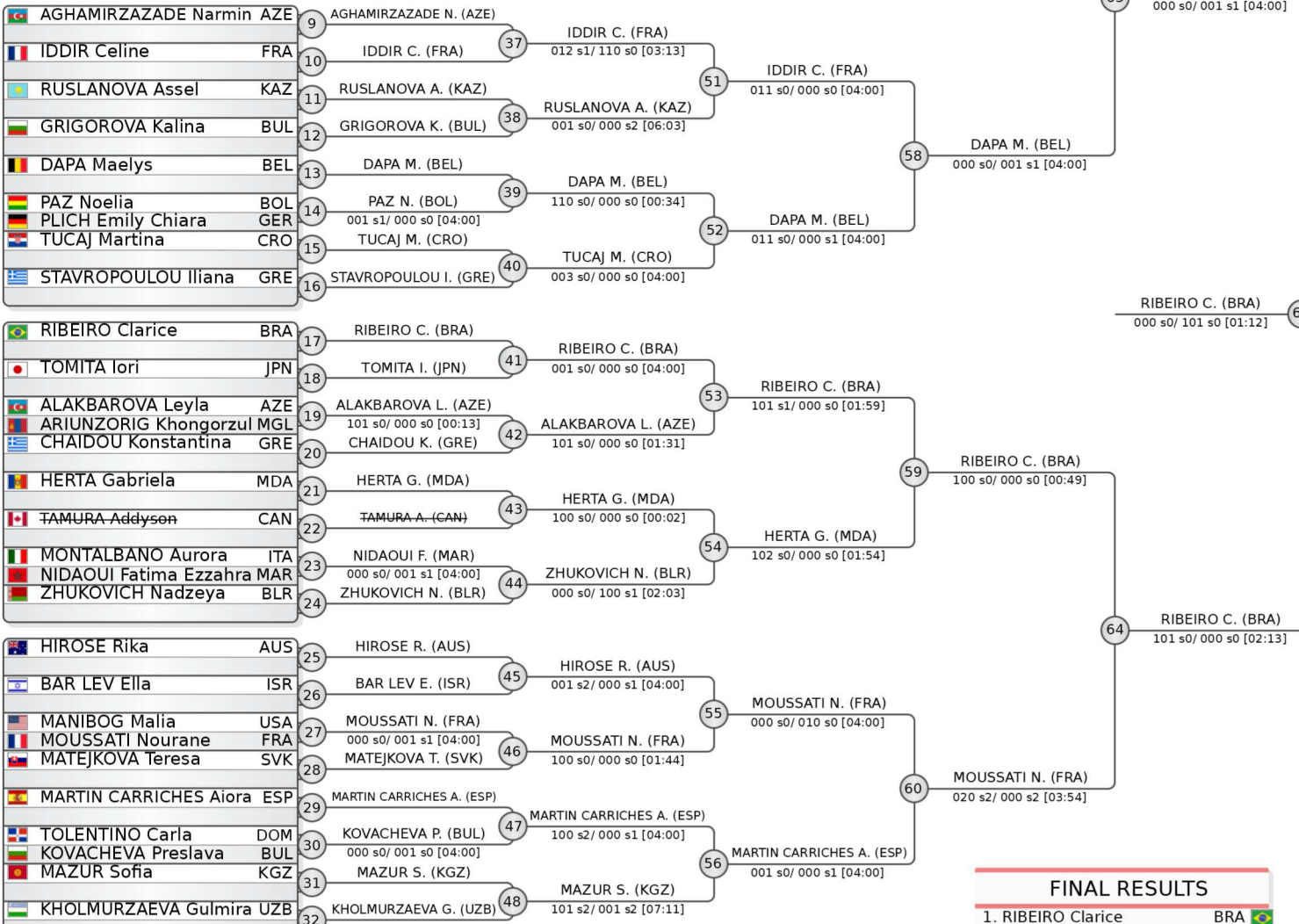
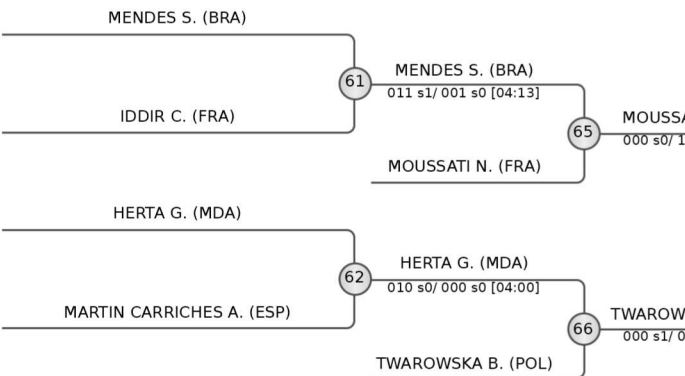

FINAL RESULTS	
1.	RIBEIRO Clarice BRA
2.	DAPA Maelys BEL
3.	MOUSSATI Nourane FRA
3.	TWAROWSKA Barbara POL
5.	MENDES Sarah BRA
5.	HERTA Gabriela MDA
7.	IDDIR Celine FRA
7.	MARTIN CARRICHES Aiora ESP





# OTP Group Sofia World Championships Cadets 2025 Individuals

## Bulgaria, Sofia, 27-30 Aug 2025

**-52 kg**  
Cadets (40)

**POOL A**

ALAOUÏ CHERIFI Amina	MAR	1
ZHUMAZHAN Inzhu	KAZ	2
QURBONZODA Madina	TJK	3
SIMIC Andjela	SRB	4
GENEREUX Aubrey	USA	5
LOPEZ Alice	FRA	6
KWAN Chui Yi	HKG	7
MAMMADOVA Aysun	AZE	8
BONZANO Giulia	ITA	9
YAHAV Yali	ISR	10

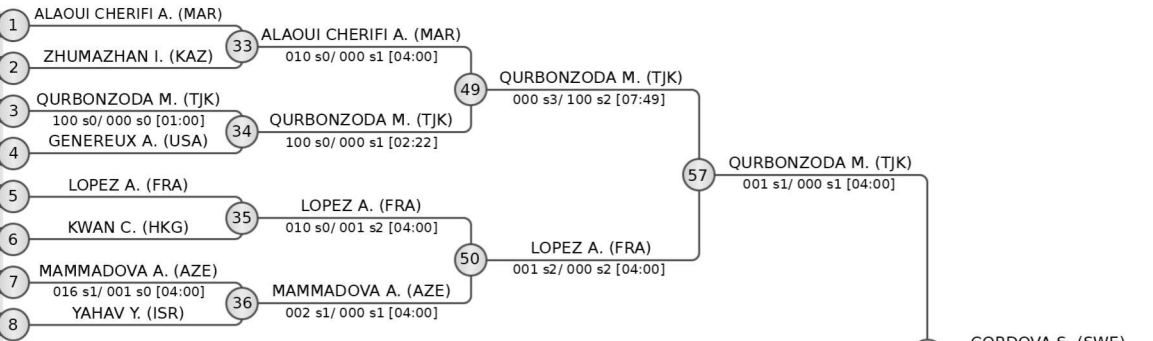

**POOL B**

GRENIER Melody	CAN	11
CHIRON Alexandra	MDA	12
MERKVLADZE Salome	GEO	13
FURMAN Polina	IJF	14
VADOVICOVA Vivien	SVK	15
BOLDBAATAR Gundegmaa	MGL	16
DZHAROVA Samira	KGZ	17
CORDOVA Sofia	SWE	18
DODAJ Sidorela	KOS	19
MOS MariKa	POL	20

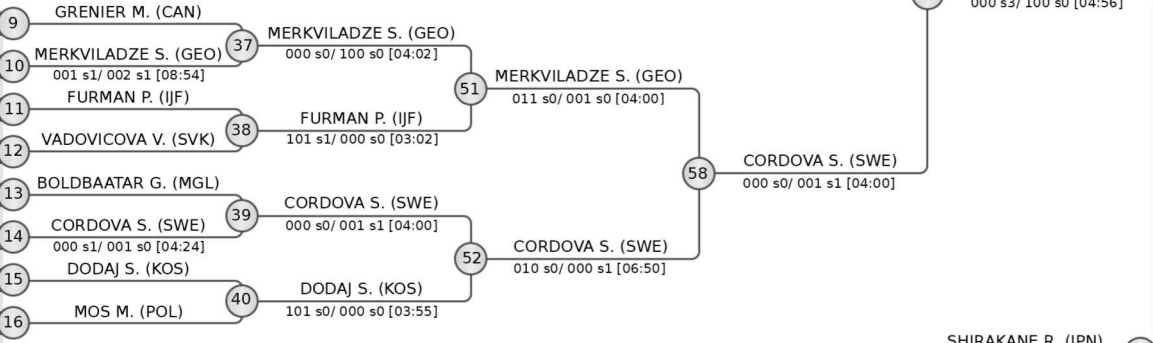

**POOL C**

KOZLOVA Valeriia	IJF	21
GULIASHVILI Mariam	GEO	22
MARKOVA Maraya	BUL	23
PAVLENCO Elizaveta	MDA	24
RAMIREZ Fatima	PAR	25
MARTINEZ DE RITUERTO MORILLAS Monica	ESP	26
UMIRZAKOVA Nigina	UZB	27
GROOTEN Maegan	CAN	28
GLAUNER Hannah	GER	29
BORUBOLOTOVA Milena	KGZ	30

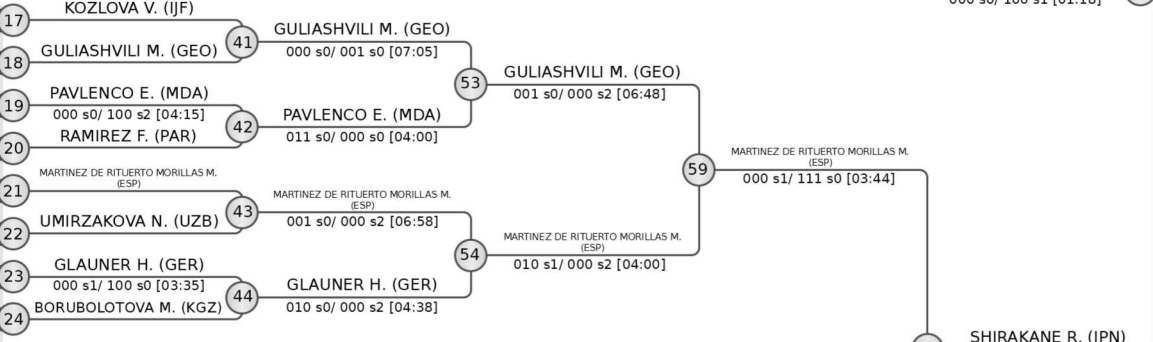

**POOL D**

MARQUES Nicole	BRA	31
AL SAIFI Sara	JOR	32
ZHARSKAYA Alisiya	BLR	33
JOVANOVIC Anja	SRB	34
MCPHERSON Mackenzie	USA	35
SUPYGALIYEVA Fatima	KAZ	36
SHIRAKANE Rio	JPN	37
BAILLEUL Helea	FRA	38
IOSIFIDOU Veroniki	GRE	39
HARANI Talya	ISR	40

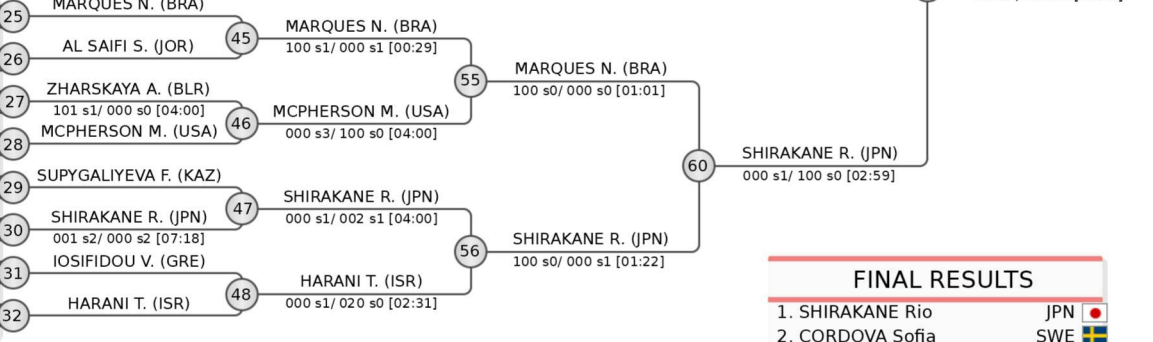

**REPECHAGE**

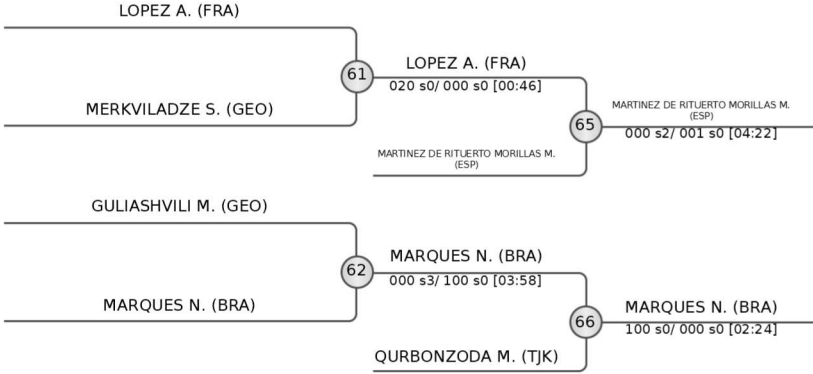

FINAL RESULTS		
1.	SHIRAKANE Rio	JPN
2.	CORDOVA Sofia	SWE
3.	MARTINEZ DE RITUERTO MORILLAS Monica	ESP
3.	MARQUES Nicole	BRA
5.	LOPEZ Alice	FRA
7.	QURBONZODA Madina	TJK
7.	MERKVLADZE Salome	GEO
7.	GULIASHVILI Mariam	GEO







# OTP Group Sofia World Championships Cadets 2025 Individuals

Bulgaria, Sofia, 27-30 Aug 2025

## -57 kg

Cadets (38)

POOL A

1	REINHOLD J. (GER)	33	REINHOLD J. (GER)
2	RUSINOVA Y. (BUL)	101 s0/000 s0 [02:17]	
3	PERRY G. (ISR)	49	REINHOLD J. (GER)
4	AKHMEDOVA M. (UZB)	34	PERRY G. (ISR)
5	MAIA M. (BRA)	35	MAIA M. (BRA)
6	KAKITAEVA A. (KGZ)	001 s1/000 s2 [04:00]	
7	YAMAKAWA N. (JPN)	50	YAMAKAWA N. (JPN)
8	YUSIFLI S. (AZE)	36	YAMAKAWA N. (JPN)
			100 s0/000 s0 [03:51]

POOL B

9	KILIC E. (TUR)	37	KILIC E. (TUR)
10	PAPASTERGIOU A. (GRE)	020 s1/000 s2 [01:39]	
11	BELOVA A. (IJF)	38	BELOVA A. (IJF)
12	BARTYIK I. (HUN)	100 s0/000 s0 [03:43]	
13	GANKHUYAG E. (MGL)	39	GANKHUYAG E. (MGL)
14	GULBANI T. (GEO)	101 s2/000 s1 [02:21]	
15	AUBERT GOMEZ M. (ESA)	52	GANKHUYAG E. (MGL)
16	SIEMKO J. (POL)	40	SIEMKO J. (POL)
			000 s0/101 s1 [02:48]

POOL C

17	MASHBAT T. (MGL)	41	MASHBAT T. (MGL)
18	BABULFATH H. (SWE)	100 s0/000 s2 [08:05]	
19	RUSU M. (MDA)	53	MASHBAT T. (MGL)
20	DIMOU D. (GRE)	42	DIMOU D. (GRE)
21	BONDARENKO M. (CAN)	000 s3/100 s2 [04:18]	
22	KHAZRATOVA G. (UZB)	43	KHAZRATOVA G. (UZB)
23	MORUZZI R. (ITA)	000 s1/001 s1 [04:00]	
24	ZHDANOVA E. (IJF)	44	ZHDANOVA E. (IJF)
			001 s2/002 s0 [07:47]

POOL D

25	WALEGA M. (POL)	45	WALEGA M. (POL)
26	KHEGAY K. (KAZ)	021 s0/010 s0 [02:36]	
27	NDOCI D. (ALB)	55	WALEGA M. (POL)
28	BOLTVAANOVA L. (SVK)	46	NDOCI D. (ALB)
29	CHASI N. (ECU)	002 s1/001 s2 [04:56]	
30	KYIALBEKOVA A. (KGZ)	47	KYIALBEKOVA A. (KGZ)
31	TATRISHVILI S. (GEO)	56	TATRISHVILI S. (GEO)
32	LEI L. (MAC)	48	TATRISHVILI S. (GEO)
			000 s1/010 s2 [04:00]
			101 s0/000 s0 [00:25]

REPECHAGE

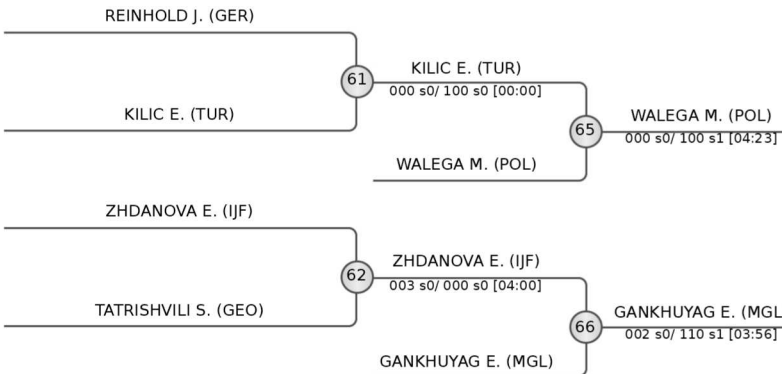

FINAL RESULTS	
1.	MASHBAT Tsendbazar MGL
2.	YAMAKAWA Nonoka JPN
3.	WALEGA Magdalena POL
4.	GANKHUYAG Enkhjin MGL
5.	KILIC Elif TUR
6.	ZHDANOVA Ekaterina IJF
7.	REINHOLD Jolina GER
7.	TATRISHVILI Sopio GEO





# OTP Group Sofia World Championships Cadets 2025 Individuals

Bulgaria, Sofia, 27-30 Aug 2025

**-63 kg**  
Cadets (31)

**POOL A**

	TSURKAN Ilariia	SLO
	LISOUSKAYA Sofya	BLR
	KOVACI Krista	ALB
	JEAN Chloe	FRA
	ANDRIC Nina	SRB
	STORM Sophia Grace	GER
	KILICKAYA Rumeysa Hatice	TUR

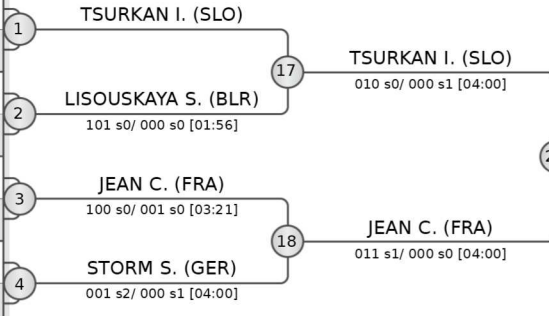

**POOL B**

	THOMSON Maia	CAN
	SPERLING Anna Julia	BRA
	SERIK Azima	KAZ
	YERMIAHU Mai	ISR
	GULBIANI Nana	GEO
	TAI TIN Lily	AUS
	ALEKSIEVA Yoana	BUL
	CHRISAKI Anni-Iris	GRE

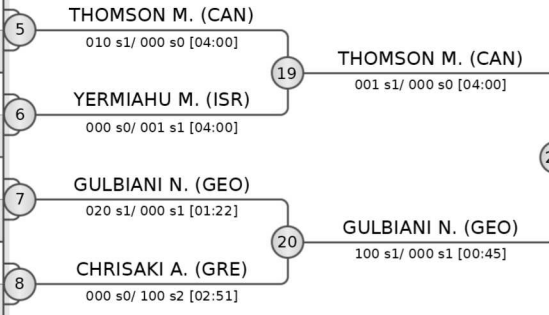

**POOL C**

	ALIEVA Aishat	IJF
	TODOROVA Elitsa	BUL
	PAVLOVIC Nevena	SRB
	TAXIDOU Eleni	GRE
	WOZNICZKO Nadia	POL
	OH Lily	USA
	RAGAUŠKAITE Viktorija	LTU
	MATUSZEKOVA Paula	SVK

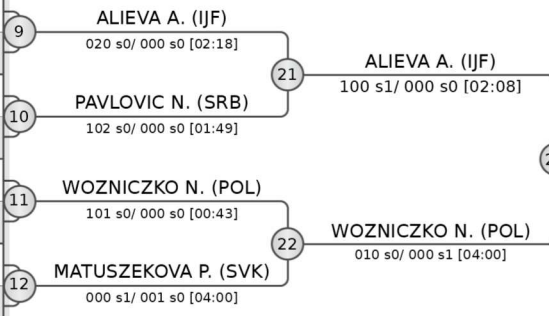

**POOL D**

	KHURELCHULUUN Maralmaa	MGL
	MORITA Nanami	JPN
	SKILJEVIC Ana	BIH
	UMAROVA Zukhrajon	UZB
	GUENNEUGUES Audren	FRA
	FONSECA Laryssa	BRA
	SUMMERS Victoria	CAN
	ARIZMENDI NGUYEN Indy	PUR

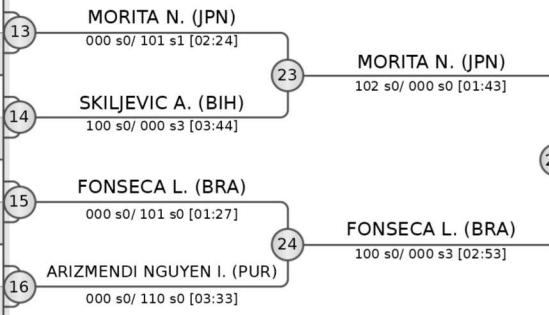

**REPECHAGE**

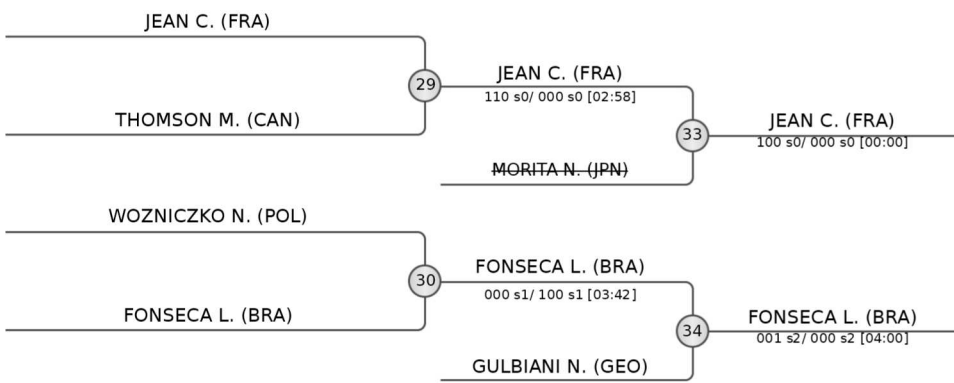

FINAL RESULTS	
1. ALIEVA Aishat	IJF
2. TSURKAN Ilariia	SLO
3. JEAN Chloe	FRA
3. FONSECA Laryssa	BRA
5. MORITA Nanami	JPN
7. THOMSON Maia	CAN
7. WOZNICZKO Nadia	POL







# OTP Group Sofia World Championships Cadets 2025 Individuals

## Bulgaria, Sofia, 27-30 Aug 2025

**-70 kg**  
Cadets (34)

**POOL A**

	RULLIER Lucie	FRA
	KURDGELIA Elene	GEO
	WILLIAMS Chloe	USA
	BOB Isabel	ROU
	DORVAL MBELE Missy Jen	CAN
	JADAMBA Delger	MGL
	PAVIC Lucia	SRB
	WOEGERER Selina	AUT
	KONOKBAEVA Azima	KGZ

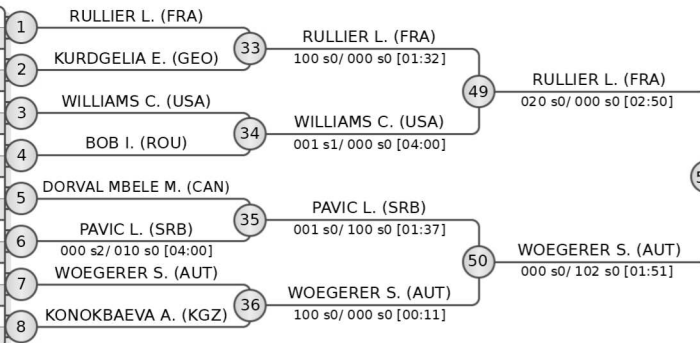

**POOL B**

	ZYS Rokšana	POL
	BESKER Ana	CRO
	VALLIM Clarisse	BRA
	MITEVA Elizabeth	BUL
	GRASSI Giorgia	ITA
	YARMANTOVICH Sofya	BLR
	TSUNEDA Kaho	JPN
	PAPAIOANNOU Maria Eleni	GRE

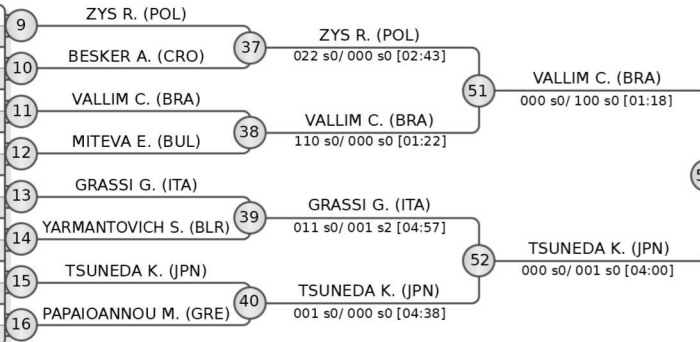

**POOL C**

	HARISS Yasmine	MAR
	MONTHE NOUSSI Chrystal	USA
	KARAFFOVA Vanessa	CZE
	MAMMADLI Masuma	AZE
	THIBAUT Charlie	CAN
	HUDIKA Vita	CRO
	WELTER Leni	LUX
	TANGARIFE Kamila	VEN

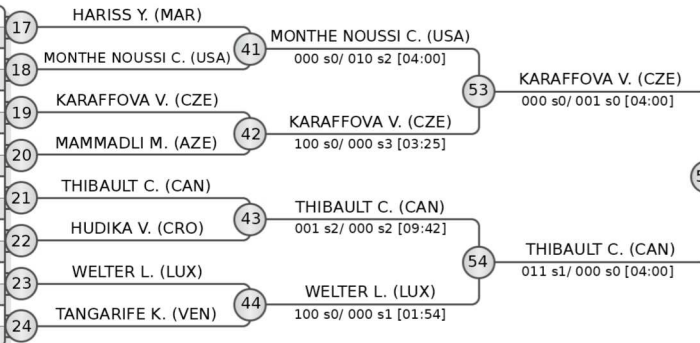

**POOL D**

	ROBAKIDZE Ket	GEO
	TOMBOU Valerie	BEL
	DUMINICA Madina	MDA
	TSENOVA Aleksandra	BUL
	MCHENRY Hannah	AUS
	MOREIRA Joana	POR
	ILIC Sara	SRB
	TURLYBEK Gulsezim	KAZ
	BENKOVA Diana	POL

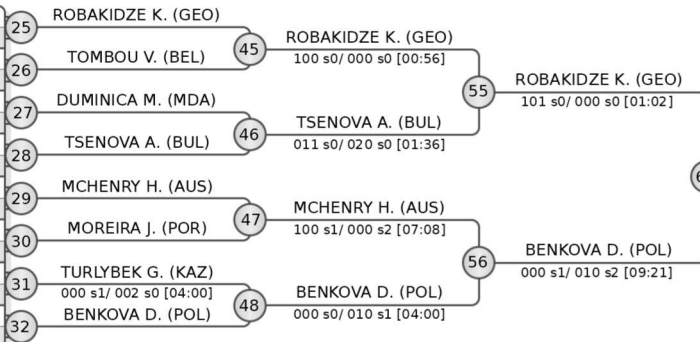

**REPECHAGE**

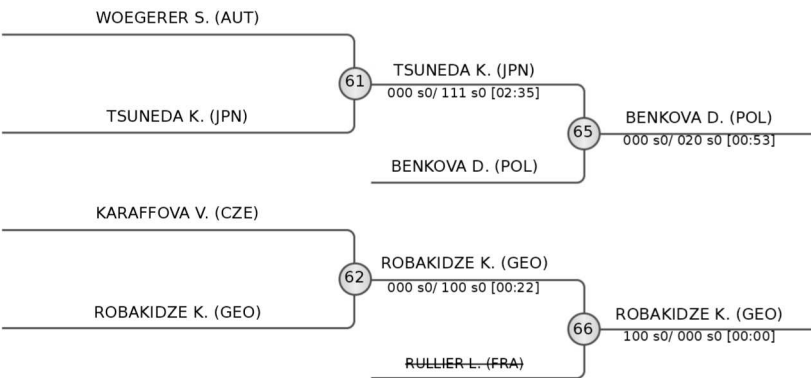

VALLIM C. (BRA) 101 s0/ 000 s0 [00:48] 67

THIBAUT C. (CAN) 000 s0/ 100 s0 [02:13] 64

THIBAUT C. (CAN) 110 s0/ 001 s0 [03:36] 64

BENKOVA D. (POL) 001 s0/ 100 s0 [02:32] 60

ROBAKIDZE K. (GEO) 100 s0/ 000 s0 [00:56] 45

BENKOVA D. (POL) 000 s0/ 010 s1 [04:00] 48

### FINAL RESULTS

- VALLIM Clarisse BRA
- THIBAUT Charlie CAN
- BENKOVA Diana POL
- ROBAKIDZE Ket
- TSUNEDA Kaho JPN
- RULLIER Lucie FRA
- WOEGERER Selina AUT
- KARAFFOVA Vanessa CZE





# OTP Group Sofia World Championships Cadets 2025 Individuals

Bulgaria, Sofia, 27-30 Aug 2025

**+ 70 kg**  
Cadets (30)

**POOL A**

	FEUILLET-NGUIMGO Emma	FRA
	I SSU TAN TA Ya-Wei	TPE
	COJUHARI Alexandrina	MDA
	MILOUDI Rym Asma	ALG
	ALIYEVA Emiliya	CAN
	GELASHVILI Barbare	GEO
	KOZONOVA Vladislava	IJF

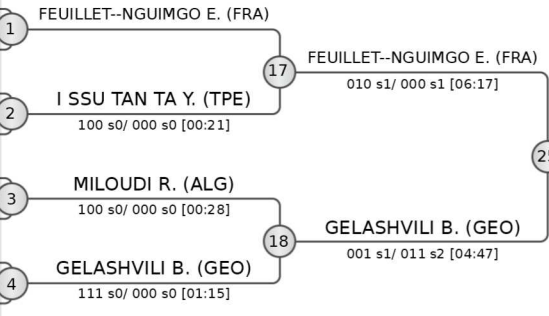

**POOL B**

	BOBONAZAROVA Zarina	UZB
	CHERKELIEVA Maria	BUL
	PALERMO Elisa	ITA
	PODZEMNA Zuzana	CZE
	TURDAZHIEVA Akmarzhan	KGZ
	EININGE Saule	LTU
	PAIXAO Agatha	BRA
	ARSTANBEKOVA Ramilya	KAZ

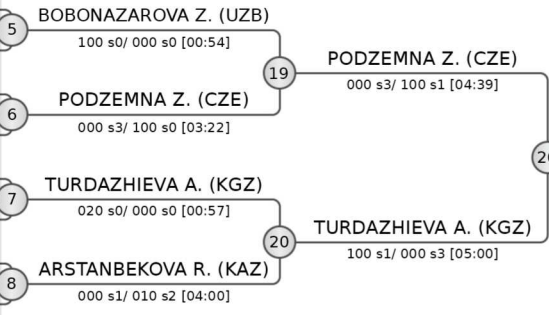

**POOL C**

	KASZPEROVA Kristyna	CZE
	BANZRAGCH Tergelnarant	MGL
	RADAKOVIC Milica	SRB
	KVARATSKHELIA Nona	GEO
	REPIAKH Aleksandra	IJF
	SMITH Abigail	CAN
	KATSUMATA Misuzu	JPN

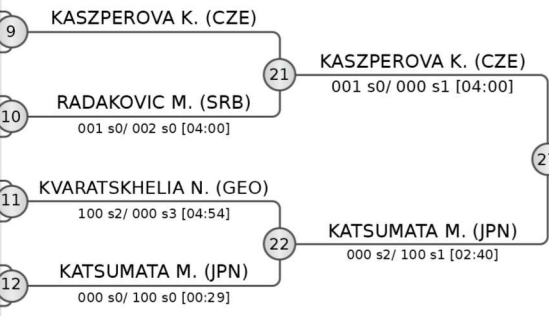

**POOL D**

	SACKO Astan	FRA
	NIGMATOVA Umida	UZB
	DILGER Elna	GER
	YORDANOVA Kalina	BUL
	AjĐUKOVIC Antea	CRO
	BALCI Hatice Tuana	TUR
	SCHIAVON Carlotta	ITA
	FERGUSON Rhadi	USA

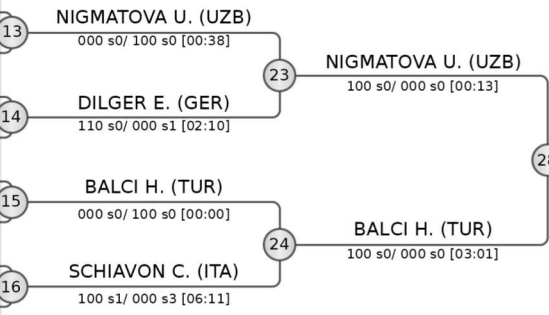

**REPECHAGE**

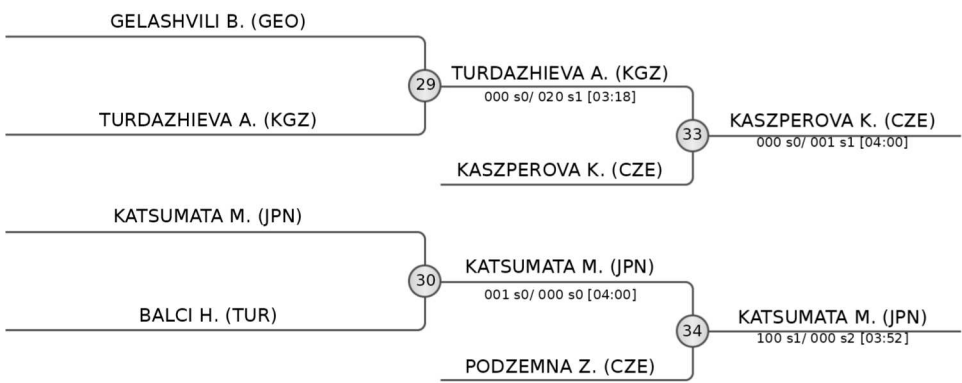

1.	NIGMATOVA Umida	UZB
2.	FEUILLET-NGUIMGO Emma	FRA
3.	KASZPEROVA Kristyna	CZE
3.	KATSUMATA Misuzu	JPN
5.	TURDAZHIEVA Akmarzhan	KGZ
5.	PODZEMNA Zuzana	CZE
7.	GELASHVILI Barbare	GEO
7.	BALCI Hatice Tuana	TUR







**POOL A**

	FRANCE	FRA
	UZBEKISTAN	UZB
	KAZAKHSTAN	KAZ
	BULGARIA	BUL

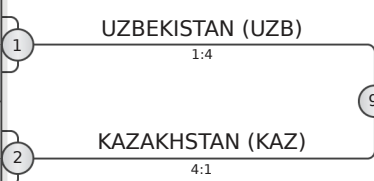

**POOL B**

	MONGOLIA	MGL
	CHINESE TAIPEI	TPE
	IJF	IJF
	GERMANY	GER

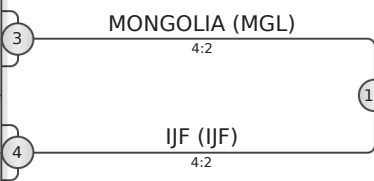

**POOL C**

	BRAZIL	BRA
	CANADA	CAN
	POLAND	POL
	GREECE	GRE

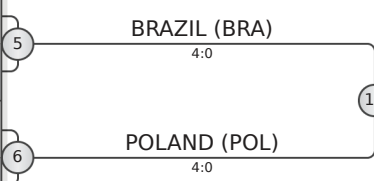

**POOL D**

	JAPAN	JPN
	BELARUS	BLR
	GEORGIA	GEO
	AZERBAIJAN	AZE

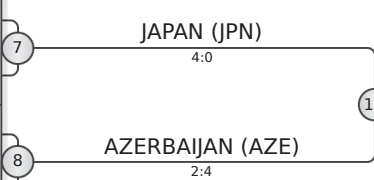

**REPECHAGE**

KAZAKHSTAN (KAZ)	
IJF (IJF)	
POLAND (POL)	
AZERBAIJAN (AZE)	

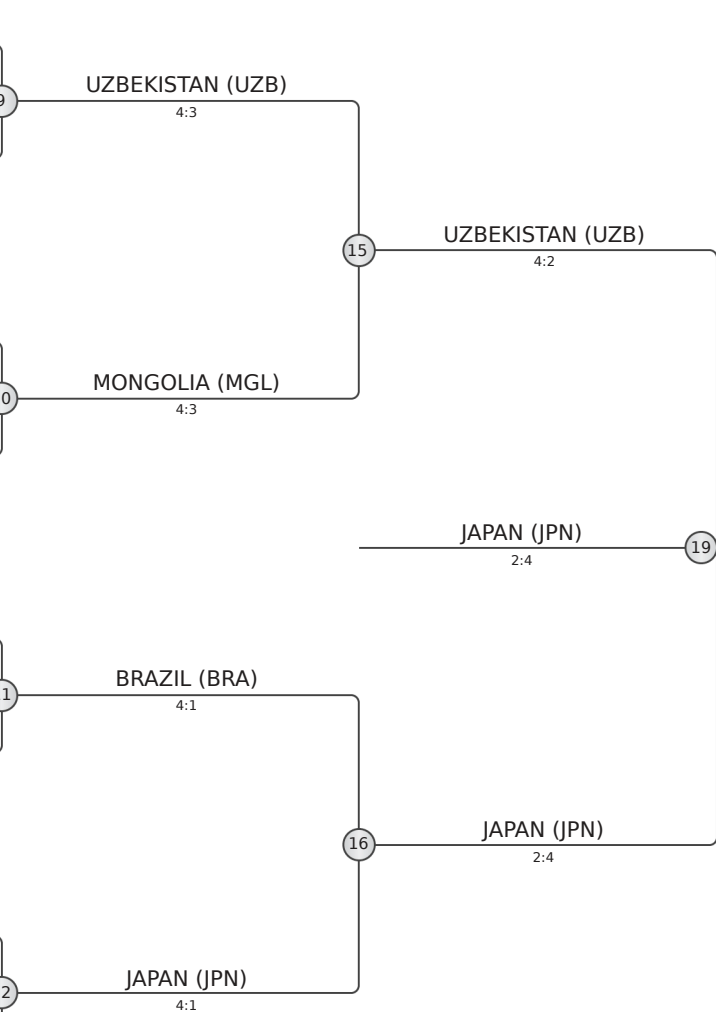
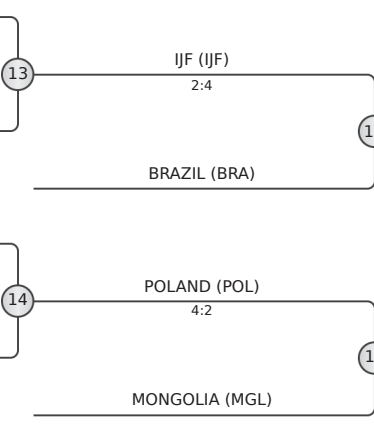

FINAL RESULTS	
1. Japan	JPN
2. Uzbekistan	UZB
3. Poland	POL
3. IJF	IJF
5. Mongolia	MGL
5. Brazil	BRA
7. Azerbaijan	AZE
7. Kazakhstan	KAZ

